



INSTALLATION INSTRUCTIONS

PSB-2243 LCD DISPLAY MOUNTING BRACKET

Prior to assembly, unpack carton completely and verify contents.

If you are missing any of the following components, please contact Customer Service at 1-800/582-6480

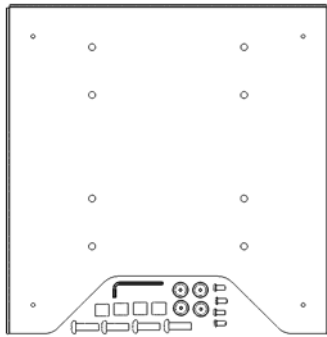

Figure 1

- (1) Interface Bracket
- (4) 10-24 x .5" Button Head Cap Screws
- (4) .740 OD x .250 ID x .250 Round Nylon Spacer

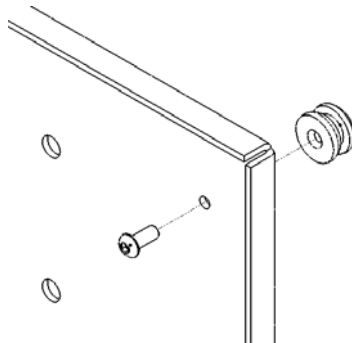

Figure 2

321

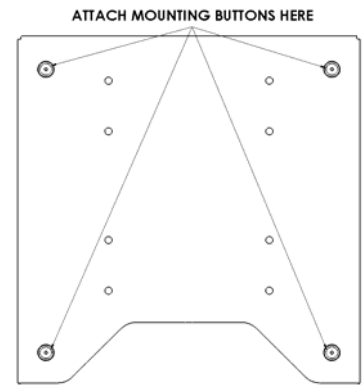

Figure 3

- (4) Mounting Buttons-Tapped 10-24
- (4) M8 x 25mm Phillips Head Cap Screws
- (1) 1/8" Allen Key

BEFORE PROCEEDING, READ INSTALLATION INSTRUCTIONS COMPLETELY

CAUTION! DISPLAYS ARE EXTREMELY FRAGILE.

1. Using a 10-24 button head cap screw inserted from back side of bracket, secure mounting button, with chamfered hole of mounting button (larger surface) facing bracket, to bracket (four places) (see Figure 2 & Figure 3).
2. Place nylon spacers on mounting holes, aligning hole pattern on brackets with pattern on back of the display
3. Using M8 screws, secure brackets to the display. Do not over tighten screws. (see Figure 4 & Figure 5).
4. With the aid of another person, lift the display up to the Chief Mount, aligning buttons on mounting bracket with slots in the Chief Mount.
5. Lower safety latch on the Chief Mount to secure the display, making sure latch is completely engaged.

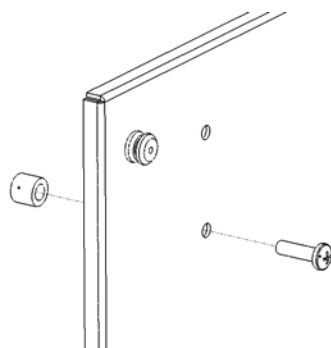

Figure 4

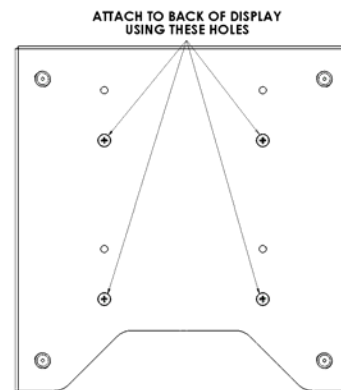

Figure 5