

INSTALLATION INSTRUCTIONS

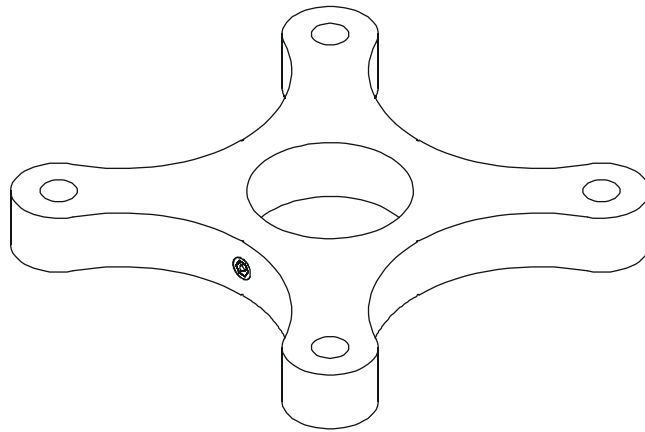

Ceiling Plates

CHRISTIE®

CMA101

DISCLAIMER

Christie Digital Systems, Inc. and its affiliated corporations and subsidiaries (collectively "Christie"), intend to make this manual accurate and complete. However, Christie makes no claim that the information contained herein covers all details, conditions or variations, nor does it provide for every possible contingency in connection with the installation or use of this product. The information contained in this document is subject to change without notice or obligation of any kind. Christie makes no representation of warranty, expressed or implied, regarding the information contained herein. Christie assumes no responsibility for accuracy, completeness or sufficiency of the information contained in this document.

Christie® is a registered trademark of Digital Systems, Inc. All rights reserved.

! IMPORTANT SAFETY INSTRUCTIONS!

! WARNING: A WARNING alerts you to the possibility of serious injury or death if you do not follow the instructions.

! CAUTION: A CAUTION alerts you to the possibility of damage or destruction of equipment if you do not follow the corresponding instructions.

! WARNING: Failure to read, thoroughly understand, and follow all instructions can result in serious personal injury, damage to equipment, or voiding of factory warranty! It is the installer's responsibility to make sure all components are properly assembled and installed using the instructions provided.

! WARNING: Failure to provide adequate structural strength for this component can result in serious personal injury or damage to equipment! It is the installer's responsibility to make sure the structure to which this component is attached can support five times the combined weight of all equipment. Reinforce the structure as required before installing the component.

! WARNING: Exceeding the weight capacity can result in serious personal injury or damage to equipment! It is the installer's responsibility to make sure the combined weight of all components attached to the CMA mount does not exceed 500 lbs (226.8 kg).

NOTE: The weight capacity of the CMA mounts may be LIMITED to the lowest weight capacity of any other component located between the ceiling plate and the projector/display.

! WARNING: Use this mounting system only for its intended use as described in these instructions. Do not use attachments not recommended by the manufacturer.

! WARNING: Never operate this mounting system if it is damaged. Return the mounting system to a service center for examination and repair.

! WARNING: Do not use this product outdoors.

IMPORTANT ! : These CMA mounts are designed for attachment to a 2" x 4" or larger wood framework ceiling.

! WARNING: Do NOT attach to vertical mounting surfaces such as walls or angled ceilings!

--SAVE THESE INSTRUCTIONS--



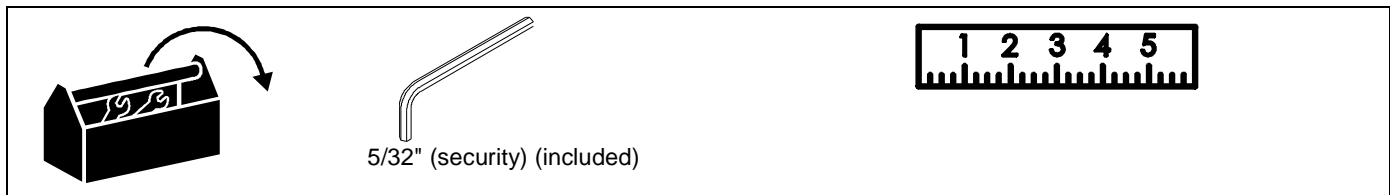



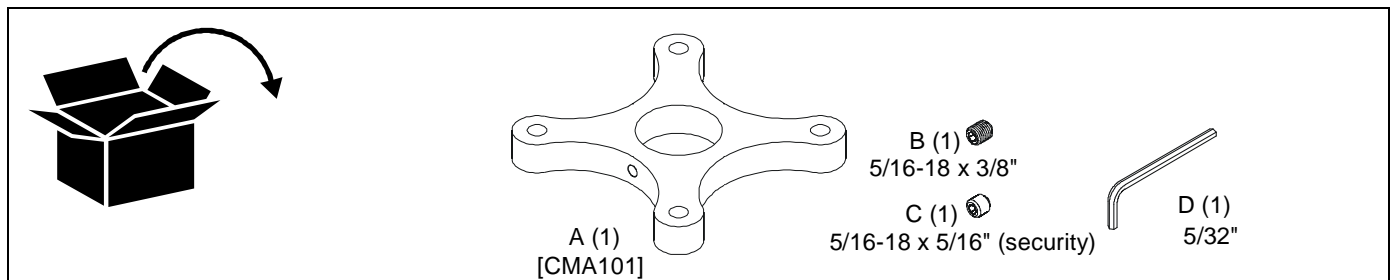





TOOLS REQUIRED FOR INSTALLATION



PARTS



LEGEND

	Tighten Fastener Apretar elemento de fijación Befestigungsteil festziehen Apertar fixador Serrare il fissaggio Bevestiging vastdraaien Serrez les fixations		Pencil Mark Marcar con lápiz Stiftmarkierung Marcar com lápis Segno a matita Potloodmerkten Marquage au crayon
	Loosen Fastener Aflojar elemento de fijación Befestigungsteil lösen Desapertar fixador Allentare il fissaggio Bevestiging losdraaien Desserrez les fixations		Drill Hole Perforar Bohrloch Fazer furo Praticare un foro Gat boren Percez un trou
	Phillips Screwdriver Destornillador Phillips Kreuzschlitzschraubendreher Chave de fendas Phillips Cacciavite a stella Kruiskopschroevendraaier Tournevis à pointe cruciforme		Adjust Ajustar Einstellen Ajustar Regolare Afstellen Ajuster
	Open-Ended Wrench Llave de boca Gabelschlüssel Chave de bocas Chiave a punte aperte Steeksleutel Clé à fourche		Remove Quitar Entfernen Remover Rimuovere Verwijderen Retirez
	By Hand A mano Von Hand Com a mão A mano Met de hand À la main		Optional Opcional Optional Opcional Opzionale Optie En option
	Hex-Head Wrench Llave de cabeza hexagonal Sechskantschlüssel Chave de cabeça sextavada Chiave esagonale Zeskantsleutel Clé à tête hexagonale		Security Wrench Llave de seguridad Sicherheitsschlüssel Chave de segurança Chiave di sicurezza Veiligheidssleutel Clé de sécurité

INSTALLATION AND ASSEMBLY

These CMA mounts are designed for attachment to a 2" x 4" or larger wood framework ceiling.



WARNING: Do NOT attach to vertical mounting surfaces such as walls or angled ceilings!



WARNING: IMPROPER INSTALLATION CAN LEAD TO LIFT FALLING CAUSING SEVERE PERSONAL INJURY OR DAMAGE TO EQUIPMENT! It is the installer's responsibility to make certain the structure to which the mount is being attached is capable of supporting five times the weight of the CMA mount and all attached equipment. Reinforce the structure as required before installing the mount.

NOTE: The following instructions assume a suitable mounting structure and surface exists prior to installation.

Installing to a Wood Framework (Joists)

1. Use 5/16-18" x 2-1/2" (minimum) Grade 2 lag screws (not provided) to secure CMA mount to the joists or wood framework, using the bolt holes noted. See Figure 1 for dimensions details.

NOTE: If using only two bolt holes for mounting, two opposing holes must be used.

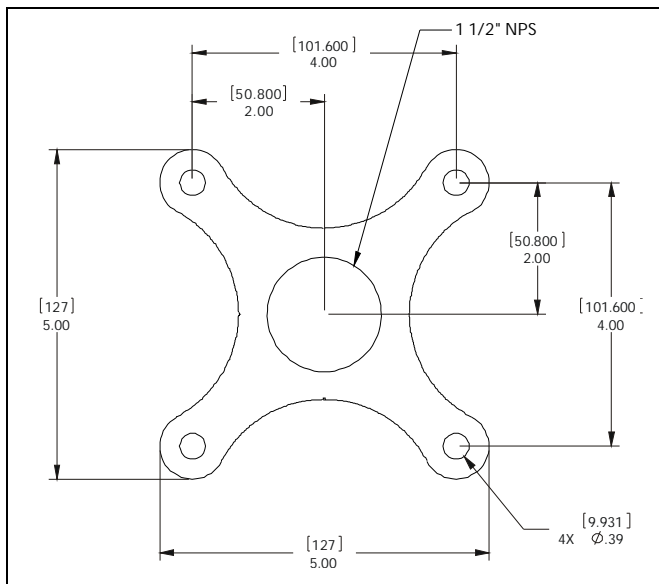

Figure 1

Attaching Column to CMA Mount (non-security)

1. Install 1-1/2" NPT or NPSM following ANSI/ASME B1.20.1 (Schedule 40, 0.154" minimum thickness aluminum - ASTM B221) threaded extension column (not included) into threaded collar until tight, with a minimum of four threads engaged. (See Figure 2)
2. Install 5/16-18 x 3/8" set screw (B) into hole on ceiling plate (A) to secure pipe to mount. (See Figure 2)

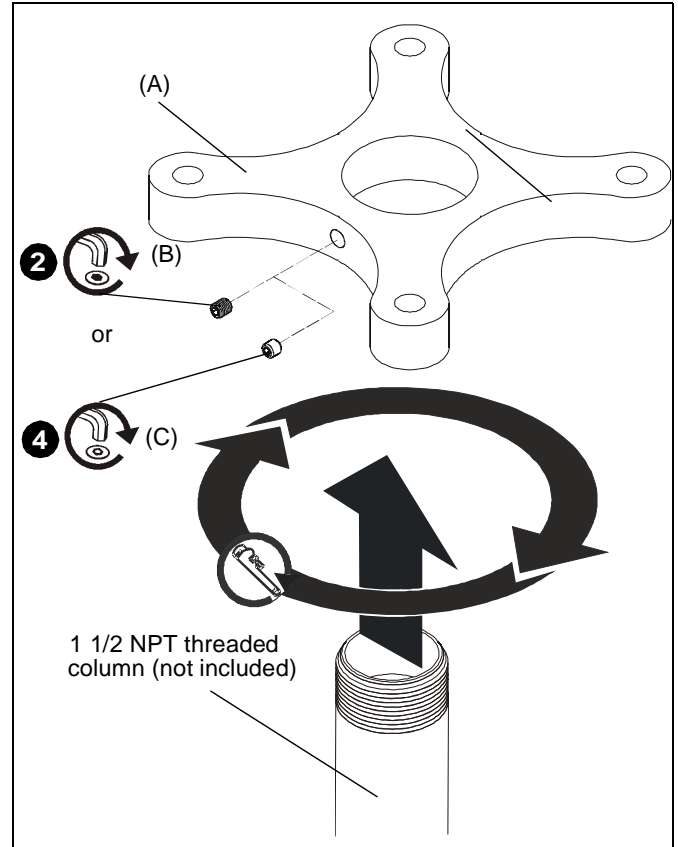

Figure 2

3. Install the ceiling mount and projector to the CMA mount using installation instructions included with the ceiling mount.

Attaching Column to CMA Mount (security)

4. Install 1-1/2" NPT or NPSM following ANSI/ASME B1.20.1 (Schedule 40, 0.154" minimum thickness aluminum - ASTM B221) threaded extension column (not included) into threaded collar until tight, with a minimum of four threads engaged. (See Figure 2)
5. Install #10-24 x 1/4" button head security screw (C) into hole on ceiling plate (A) to secure pipe to mount. (See Figure 2)
6. Install the ceiling mount and projector to the CMA mount using installation instructions included with the ceiling mount.

Christie Digital Systems USA, Inc.

USA

Toll Free: 1-800-221-8025

PH: 519-744-8005

FX: 519-749-3302

Monday - Friday 8:00 am - 8:00 pm EST

Canada

Toll Free: 1-800-221-8025

PH: 519-744-8005

FX: 519-749-3302

Monday - Friday 8:00 am - 8:00 pm EST

Chile

PH: 519-744-8005

FX: 519-749-3302

Monday - Friday 8:00 am - 8:00 pm EST

Singapore

PH: +65 6877-8737

FX: +65 6877-8747

Monday - Friday 9:00 am - 5:00 pm SST

China

PH: +86 10 6561 0240

FX: +86 10 6561 0546

Monday - Friday 9:00 am - 5:00 pm CST

Japan

PH: 81-3-3599-7481

FX: 81-3-3599-7482

Monday - Friday 9:00 am - 5:00 pm JST

South Korea

PH: +82 2 702 1601

FX: +82 2 702 1602

Monday - Friday 9:00 am - 5:00 pm KST

India

PH: +91 (080) 41468940

FX: +91 (080) 41468949

Monday - Friday 9:00 am - 5:00 pm IST

United Kingdom

PH: +44 (0) 118 977 8111

FX: +44 (0) 118 977 8112

Monday - Friday 8:30 am - 5:00 pm GMT

France

PH: +33 (0)1 41 21 44 10

FX: +33 (0)1 41 21 00 36

Monday - Friday 10:00 am - 6:00 pm CEST

Germany

PH: +49 2161 56620 22

FX: +49 2161 6645 46

Monday - Friday 8:30 pm - 5:30 pm CEST

Eastern Europe

PH: +44 (0) 118 977 8111

FX: +44 (0) 118 977 8112

Monday - Friday 8:30 am - 5:00 pm GMT

Middle East

PH: +44 (0) 118 977 8111

FX: +44 (0) 118 977 8112

Monday - Friday 8:30 am - 5:00 pm GMT

Spain

PH: + 34 91 633 9990

FX: + 3491 633 9991

Monday - Friday 9:00 am - 5:00 pm CEST

Italy

PH: +39 (0)2 9902 1161

FX: +39 (0)2 9902 2641

Monday - Friday 9:00 am - 5:00 pm CEST

Africa

PH: +44 (0) 118 977 8111

FX: +44 (0) 118 977 8112

Monday - Friday 8:30 am - 5:00 pm GMT

CHRISTIE®8800-002249 Rev00
11/12**Christie Digital Systems USA, Inc.**10550 Camden Drive
Cypress, CA 90630
www.christiedigital.com