INSTALLATION INSTRUCTIONS

ELEFUJ61-SML Static Wall Mount With Lateral Shift

Prior to assembly, unpack carton completely and verify contents. If you are missing any of the following components, please contact Technical Support at 1-800-776-5768.

Static Wall Mount Components

- (1) PLASMA STATIC WALL MOUNT
- (2) SCREW, 10-24 X .5 FH UNDERCUT
- (2) LATCH, SAFETY
- (2) NUT, NYLOCK, 10-24
- (2) WASHER, NYLON
- (4) M8 X 40MM BUTTON HEAD CAP SCREWS
- (4) MOUNTING BUTTONS-NYLON
- (1) WRENCH, ALLEN, M5

Lateral Shift Components

- (2) LATERAL SHIFT EXTRUSIONS
- (4) STUDS, 5/16-18 Threaded
- (4) NUTS, T-slot 5/16-18
- (4) WASHERS, Lock 5/16
- (4) WASHERS, Flat 5/16
- (4) SCREWS, Panhead Self Tapping
8 x .25
- (4) NUTS, Hex 5/16-18



Static Wall Mount
Components

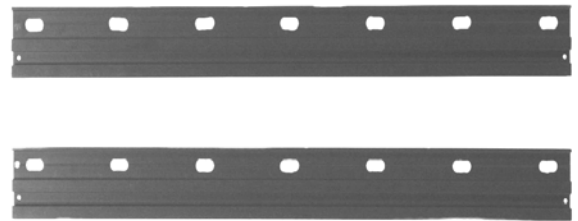
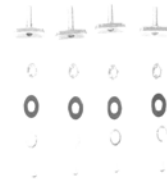

Lateral Shift
Components

WARNING: IMPROPER INSTALLATION MAY RESULT IN SERIOUS PERSONAL INJURY!

CAUTION: PLASMA DISPLAYS ARE EXTREMELY FRAGILE!

INSTALLATION INSTRUCTIONS

READ COMPLETELY BEFORE PROCEEDING

Assemble Lateral Shift

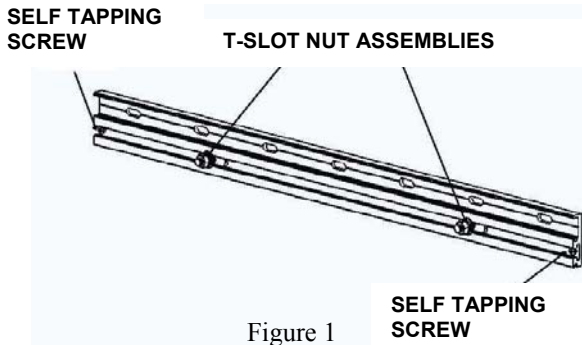

Figure 1

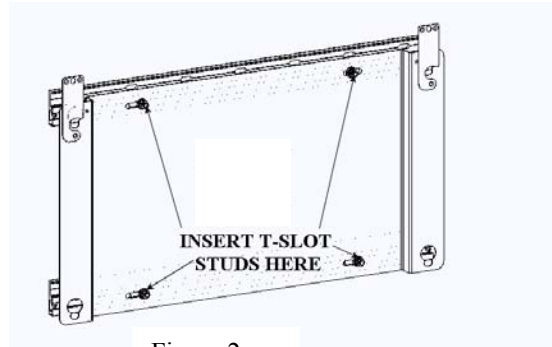

Figure 2

1. Install the four threaded studs into the four T-slot nuts.
2. Insert two T-slot nut assemblies into each of the lateral shift extrusions (Figure 1).
3. Insert one self-tapping screw into each end of the extrusions to trap T-slot nut assemblies in the tracks (Figure 1).
4. Connect lateral shift extrusions to the plasma static wall mount by inserting the T-slot studs into holes and secure using four flat washers, four lock washers, and four hex nuts (Figure 2).

Mount Lateral Shift

1. Locate and mark stud locations at desired mounting place.
2. Select four mounting holes in the lateral shift extrusions that will align with the stud pattern and mark at least two mounting holes in each extrusion at the stud locations.

WARNING: Your mounting structure must be capable of supporting four times the combined weight of the plasma and the mount.

3. Mount the extrusions using a minimum of four anchors.

Mount Plasma

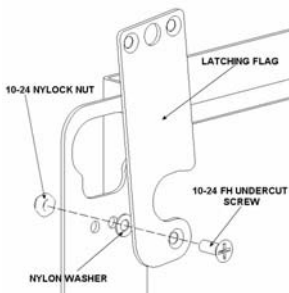

Figure 2

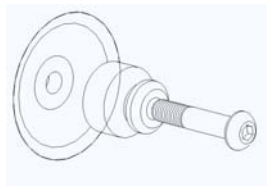

Figure 3

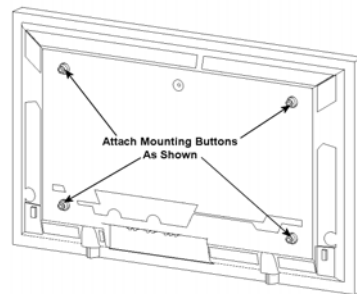

Figure 4



1. Attach mounting buttons to plasma using six M8 x 20 cap screws provided for each mounting button (Figures 2 & 3).
2. Using two 10-24 x .5 FH undercut screws, Nylon washers between safety latch and mount, and 10-24 Nylock nuts, install the safety latches loose enough to move but tight enough to remain in place when raised.
3. Make sure the latches on the mount are lowered to the side before attempting to place the display on the mount.
4. With the aid of another person, lift the display up to the mount. Align the mounting buttons on the display with the teardrop slots on the mount and set the display into place (Figure 4).

CAUTION If the latches will not travel to the full upright position, remove and reseat the display.

5. While supporting the display, raise both latches to secure the display.