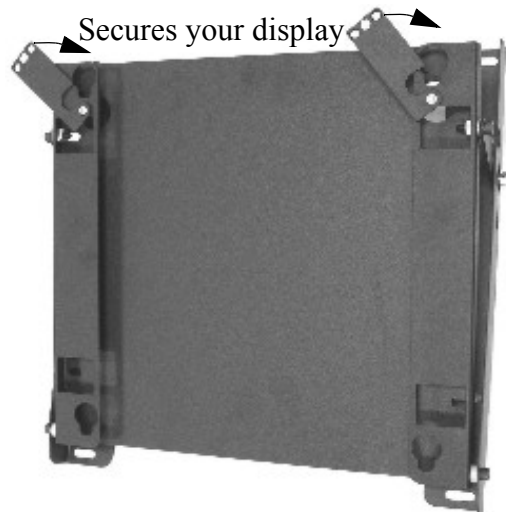

INSTALLATION INSTRUCTIONS

ELEZEN42 - PROL Pitch Adjustable Wall Mount with Lateral Shift

The wall mount is a quick disconnect mounting system furnishing pitch adjustability between 0 and 15 degrees. With the display-specific bracket(s) attached to your plasma display, simply attach the mount securely to a structure, lock the display and bracket(s) in place using the convenient Q-latches, and attach your audio/video cables.

The mount also includes lateral shift capability to allow spanning a 24" on-center stud pattern, or 4" lateral shift on either side of a 16" on-center stud pattern.

When the display is mounted, your mount is virtually invisible.



BEFORE YOU BEGIN

- **Caution:** To prevent damage to the mount, which could void factory warranty and affect the attached equipment, thoroughly study all instructions and illustrations before you begin the installation. Pay particular attention to the "Important Warnings and Precautions" on Page 1.
- The mount is designed to be installed using wall studs or supporting framework. The fasteners used to anchor the mount must be capable of supporting four times the total weight of the equipment.
- If you have any questions about this installation, contact *Technical Support at 1-800-776-5768*.



IMPORTANT WARNINGS AND PRECAUTIONS!

WARNING: A **WARNING** alerts you to the possibility of serious injury or death if you do not follow the instructions.

CAUTION: A **CAUTION** alerts you to the possibility of damage or destruction of equipment if you do not follow the corresponding instructions.

- **WARNING: Improper installation can result in serious personal injury! Make sure that the structural framework can support a weight factor *four times* the total weight of the equipment. If not, reinforce the structure before installing the mount.**
- **WARNING: Be aware of the potential for personal injury or damage to the unit if it is not adequately mounted.**
- **WARNING: The installer is responsible for verifying that the mounting structure to which the mount is anchored will safely support the combined load of all attached components or other equipment.**
- **WARNING: Watch for pinch points. Do not put your fingers between movable parts.**
- **WARNING: Make sure the mount and brackets are correctly oriented.**
- **WARNING: Make sure the latching flags securing the display are completely engaged at all times *except* when removing or installing the display. The latching flags must be completely engaged when installing/removing cables.**
- **CAUTION:** Check the mount for shipping damage before you begin the installation.
- **CAUTION:** When attaching bracket(s) to back of plasma display, use only the mounting screws provided and **DO NOT OVER TIGHTEN** mounting screws.

CONTENTS

ASSEMBLE LATERAL SHIFT	2
MOUNT LATERAL SHIFT	2
INSTALL PLASMA BRACKET	3
INSTALL MOUNT	3
ADJUST MOUNT	3
PARTS	4
Wall Mount Parts	4
Lateral Shift Parts	5

TOOLS REQUIRED FOR INSTALLATION

- Phillips Screwdrivers, No. 1 and No. 2 TIP
- Drill and Bit Set
- Wrench Set

NOTE: Other tools may be required depending on the method of installation.

ASSEMBLE LATERAL SHIFT

1. Install the four threaded studs into the the four T-slot nuts.
2. Insert two T-slot nut assemblies into each of the lateral shift extrusions (Figure 1).
3. Insert one self-tapping screw into each end of the extrusions to trap T-slot nut assemblies in the track.
4. Connect lateral extrusions to the plasma wall mount by inserting the T-slot studs into holes and secure using four flat washers, four lock washers and four hex nuts (Figure 2).

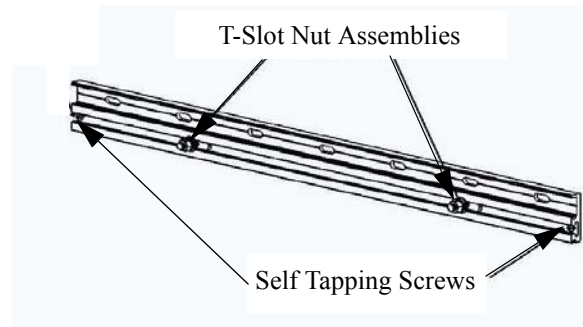

Figure 1. T-Slot Nuts and Self Tapping Screws

MOUNT LATERAL SHIFT

1. Locate and mark stud locations at desired mounting location.
2. Select four mounting holes in the lateral shift extrusions that will align with the stud pattern and mark at least two mounting holes per extrusion at the stud locations.

WARNING: Improper installation can result in serious personal injury! Make sure that the structural framework can support a weight factor *four times* the total weight of the equipment. If not, reinforce the structure before installing the mount.

3. Mount the extrusions using a minimum of four anchors.

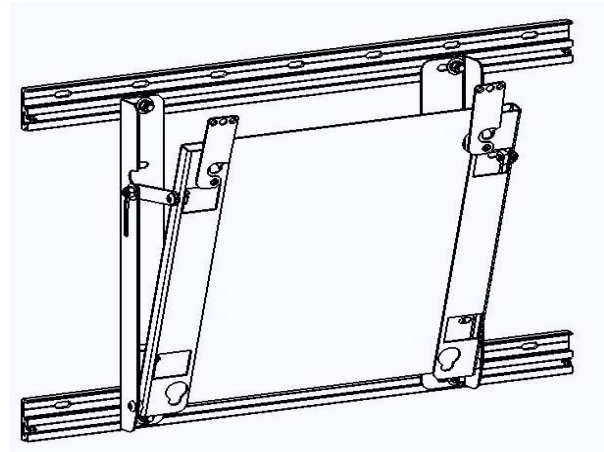

Figure 2. Secure Mount

INSTALL PLASMA BRACKET

Install plasma bracket(s) according to the instructions provided. The bracket(s) is/are designed for your specific plasma display model.

INSTALL MOUNT

NOTE: If using lateral shift brackets, see Step 4 of "ASSEMBLE LATERAL SHIFT" on page 2.

1. Determine the exact mounting location prior to installation and draw a level line to indicate the desired height for the top of the mounting plate.

WARNING: Improper installation can result in serious personal injury! Make sure that the structural framework can support a weight factor *four times* the total weight of the equipment. If not, reinforce the structure before installing the mount.

2. With the mount correctly oriented and level, secure the mount to the wall (Figure 3) using four fasteners (not included). Fasteners must be driven into the supporting wall studs or other supporting framework.
3. Check mount to ensure it is level and adjust if necessary.

ADJUST MOUNT

1. Loosen the nut and socket head cap screw, slightly, on each adjustment arm (Figure 4).
2. Position mounting plate to desired angle.
3. Tighten the nut and socket head cap screw on each adjustment arm (Figure 4).
4. Ensure all socket head cap screws are tightened.

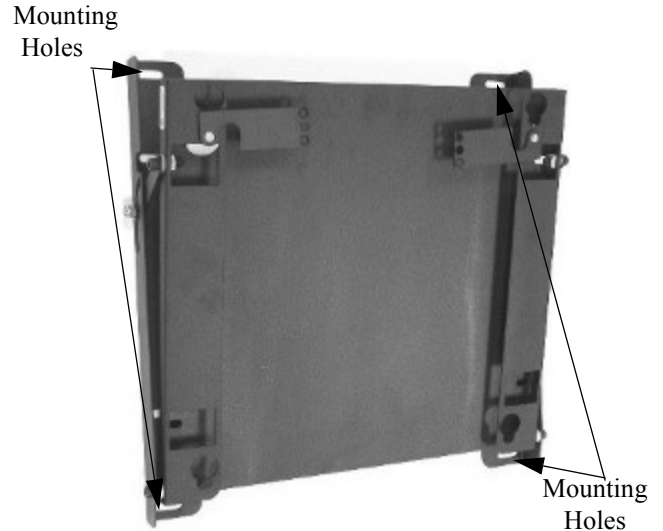

Figure 3. Mounting Hole Locations

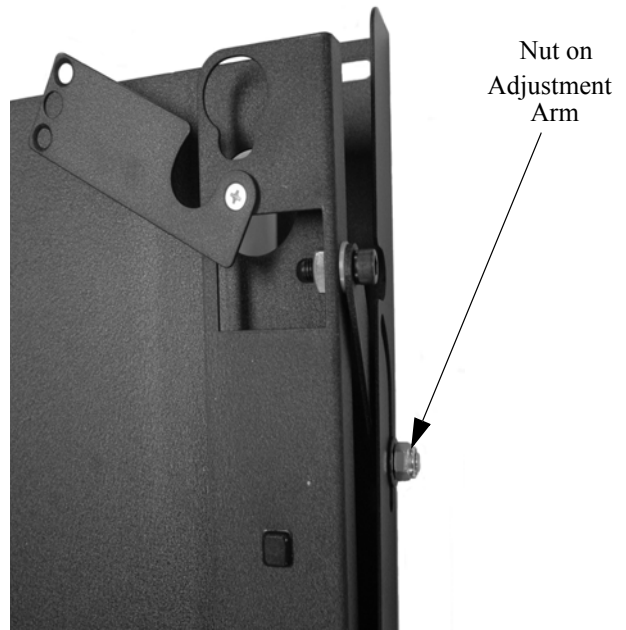

Figure 4. Adjustment arm

PARTS

Table 1: Wall Mount Parts

Ref	Description	Qty	Ref	Description	Qty
1	BRACKET, tilt, left	1	9	NUT, Nylock, #10	2
2	BRACKET, tilt, right	1	10	WASHER, Nylon, 1/32"	2
3	MOUNT, static	1	11	SCREW, cap, flat-head, #10	2
4	LATCH, safety	2	12	NUT, Nylock, 5/16"	2
5	ARM, tilt	2	13	WASHER, flat, 5/16"	2
6	NUT, square, 5/16"	4	14	WASHER, Nylon, 1/16"	4
7	WASHER, lock, 5/16"	4	15	SPACER, Nylon, 1/4"	2
8	SCREW, cap, socket-head, 5/16"	4			

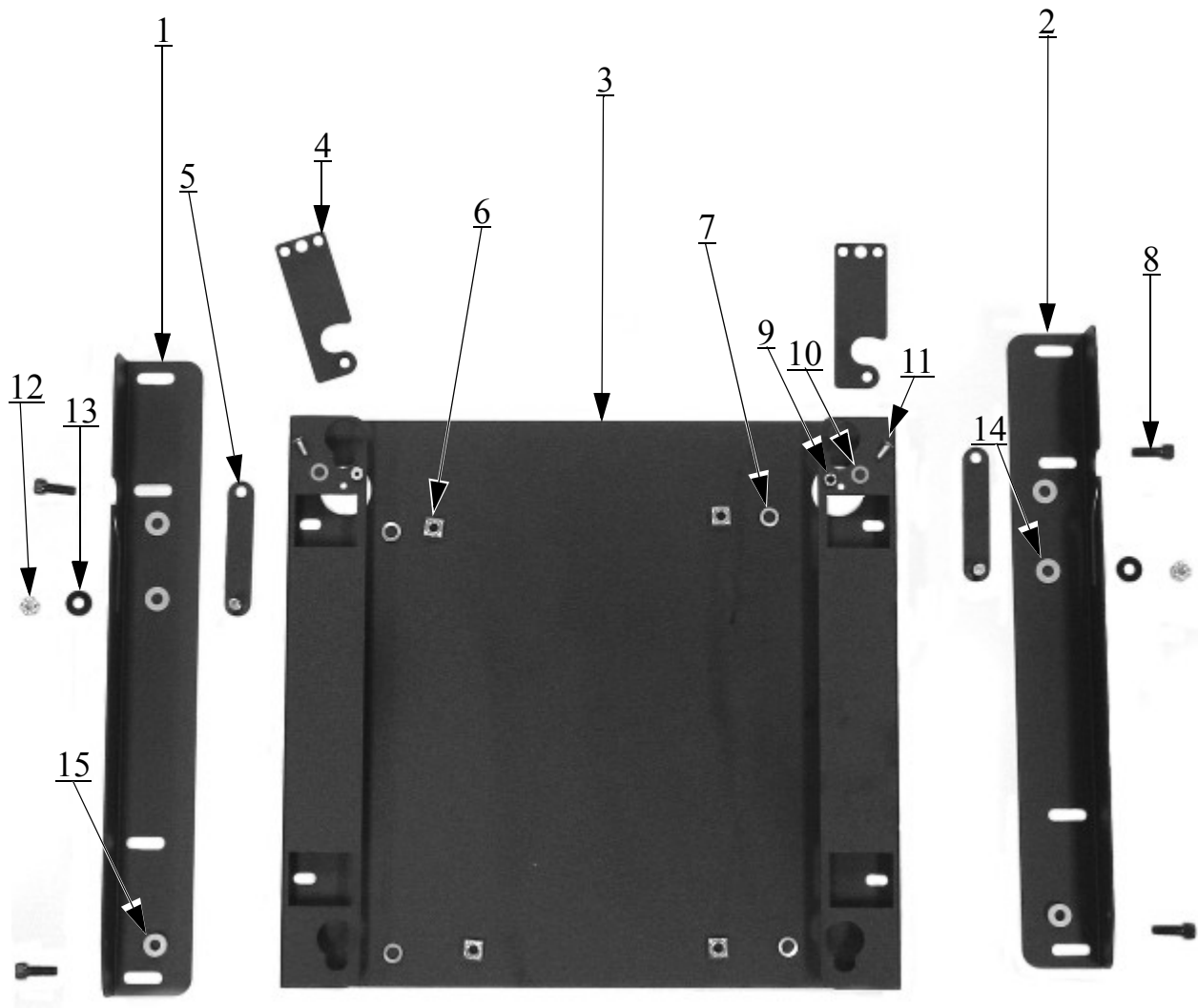

Table 2: Lateral Shift Parts

Ref	Description	Qty	Ref	Description	Qty
1	EXTRUSION, lateral shift	2	5	WASHER, flat, 5/16"	4
2	STUD, threaded, 5/16-18	4	6	WASHER, lock, 5/16"	4
3	NUT, T-slot, 5/16-18	4	7	SCREW, panhead, self tapping, 8 X .25"	4
4	NUT, hex, 5/16-18	4			

