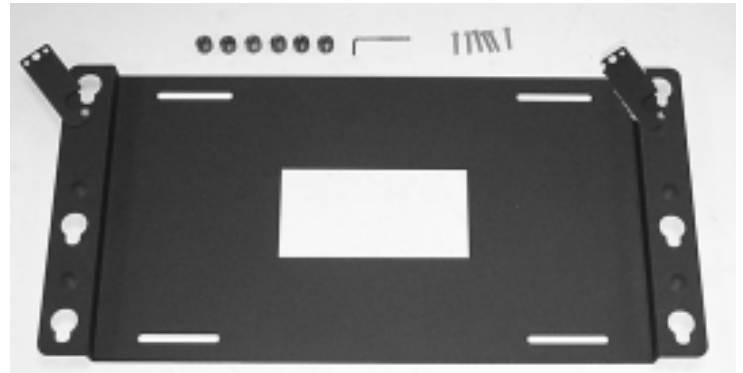

INSTALLATION INSTRUCTIONS

ELEZEN42-SML Static Wall Mount With Lateral Shift

Prior to assembly, unpack carton completely and verify contents. If you are missing any of the following components, please contact Technical Support at 1-800-776-5768.

Static Wall Mount Components

- (1) PLASMA STATIC WALL MOUNT
- (6) MOUNTING BUTTON-Green
- (6) SCREW, M5-.8 x 25mm BHCS
- (6) WASHER Nylon .75 OD x .323 ID x .125
- (2) FLAG, Latching
- (2) WASHER, Nylon .500" OD x .312" ID x .0312"
- (2) SCREW, 10-24 x .5 FH Undercut
- (2) NUT, Nylock 10-24
- (1) KEY, Allen, 3mm



Static Wall Mount
Components



Lateral Shift Components

- (2) LATERAL SHIFT EXTRUSIONS
- (4) STUDS, 5/16-18 Threaded
- (4) NUTS, T-slot 5/16-18
- (4) WASHERS, Lock 5/16
- (4) WASHERS, Flat 5/16
- (4) SCREWS, Panhead Self Tapping 8 x .25
- (4) NUTS, Hex 5/16-18



Lateral Shift
Components

WARNING: IMPROPER INSTALLATION MAY RESULT IN SERIOUS PERSONAL INJURY!

CAUTION: PLASMA DISPLAYS ARE EXTREMELY FRAGILE!

INSTALLATION INSTRUCTIONS

READ COMPLETELY BEFORE PROCEEDING

Assemble Lateral Shift

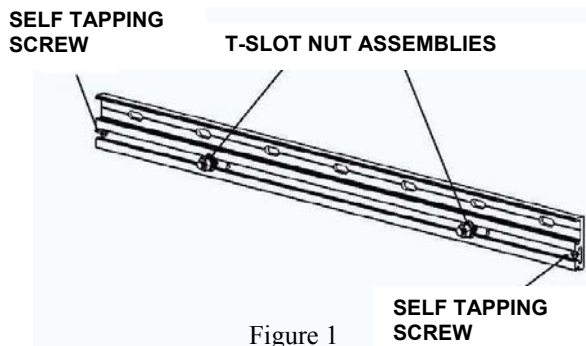

Figure 1

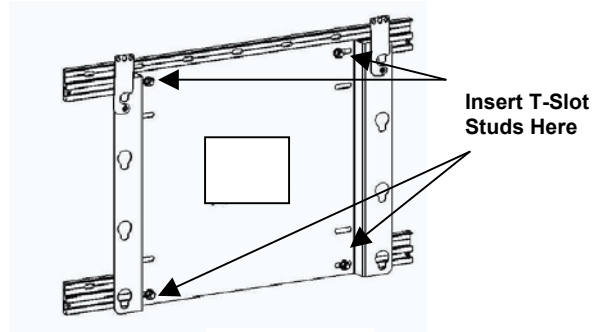

Figure 2

1. Install the four threaded studs into the four T-slot nuts.
2. Insert two T-slot nut assemblies into each of the lateral shift extrusions (Figure 1).
3. Insert one self-tapping screw into each end of the extrusions to trap T-slot nut assemblies in the tracks (Figure 1).
4. Connect lateral shift extrusions to the plasma static wall mount by inserting the T-slot studs into holes and secure using four flat washers, four lock washers, and four hex nuts (Figure 2).

Mount Lateral Shift

1. Locate and mark stud locations at desired mounting place.
2. Select four mounting holes in the lateral shift extrusions that will align with the stud pattern and mark at least two mounting holes per extrusion at the stud locations.

WARNING: Your mounting structure must be capable of supporting four times the combined weight of the plasma and the mount.

3. Mount the extrusions using a minimum of four anchors.

Mount Plasma

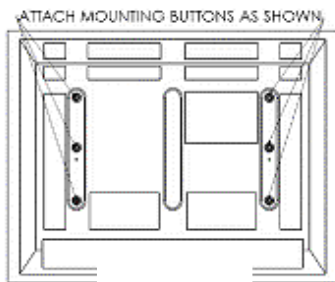

Figure 2

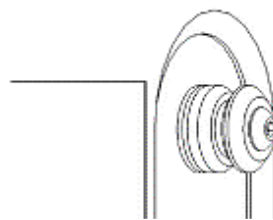

Figure 3

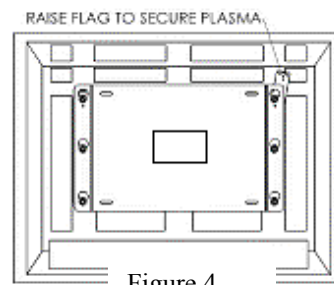

Figure 4

1. Attach mounting buttons to plasma utilizing the enclosed button head cap screws, mounting buttons, And 1 spacer under each button (See Figures 2 & 3).
2. Using two 10-24 x .5 FH undercut screws, Nylon washers between safety latch and mount, and 10-24 Nylock nuts, install the safety latches loose enough to move but tight enough to remain in place when raised.
3. Mount plasma static mount onto wall utilizing wall studs or supporting framework. The mount, when anchored in place, must be capable of supporting 4 times the weight of the plasma and mount.
4. With the aid of another person, lift plasma display up to the Chief mount, aligning mounting buttons with the teardrop slots and setting into place (See Figure 4).
5. Raise both safety latches to secure plasma in place.