

INSTALLATION INSTRUCTIONS

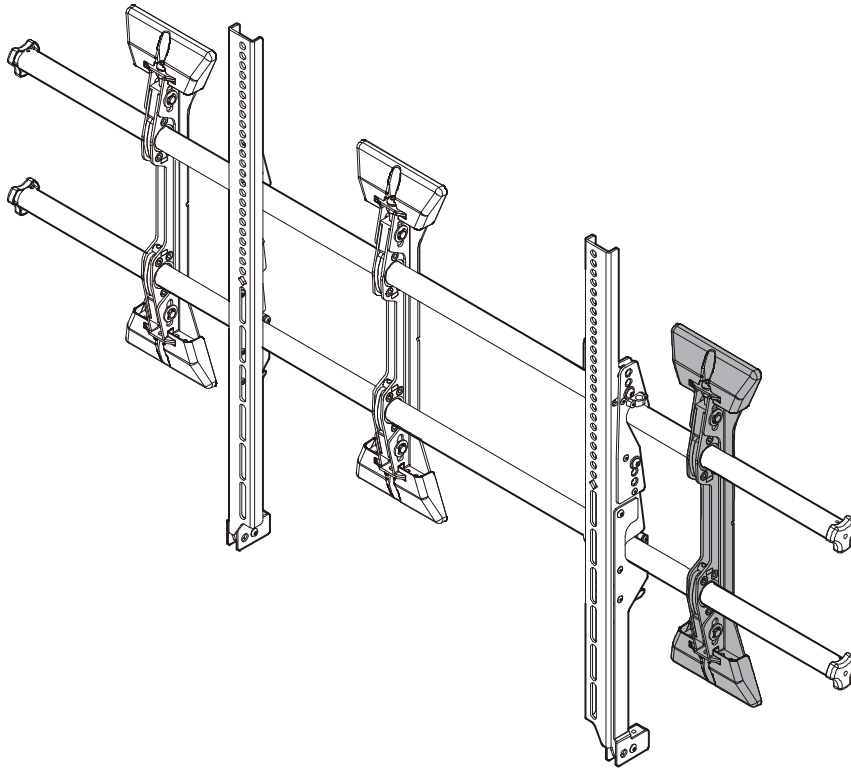

Extra Fusion™ Wall Plate

DISCLAIMER

Milestone AV Technologies and its affiliated corporations and subsidiaries (collectively "Milestone"), intend to make this manual accurate and complete. However, Milestone makes no claim that the information contained herein covers all details, conditions or variations, nor does it provide for every possible contingency in connection with the installation or use of this product. The information contained in this document is subject to change without notice or obligation of any kind. Milestone makes no representation of warranty, expressed or implied, regarding the information contained herein. Milestone assumes no responsibility for accuracy, completeness or sufficiency of the information contained in this document.

Chief® is a registered trademark of Milestone AV Technologies. All rights reserved.

! IMPORTANT SAFETY INSTRUCTIONS

! WARNING: A WARNING alerts you to the possibility of serious injury or death if you do not follow the instructions.

! CAUTION: A CAUTION alerts you to the possibility of damage or destruction of equipment if you do not follow the corresponding instructions.

! WARNING: Failure to read, thoroughly understand, and follow all instructions can result in serious personal injury, damage to equipment, or voiding of factory warranty! It is the installer's responsibility to make sure all components are properly assembled and installed using the instructions provided.

! WARNING: Exceeding the weight capacity can result in serious personal injury or damage to equipment! Adding the FCA115 wall plate to the XSM1U/XTM1U wall mount provides additional support but does not change the weight capacity listed for the mount.

! WARNING: Use this mounting system only for its intended use as described in these instructions. Do not use attachments not recommended by the manufacturer.

! WARNING: Never operate this mounting system if it is damaged. Return the mounting system to a service center for examination and repair.

! WARNING: Do not use this product outdoors.

--SAVE THESE INSTRUCTIONS--

DIMENSIONS

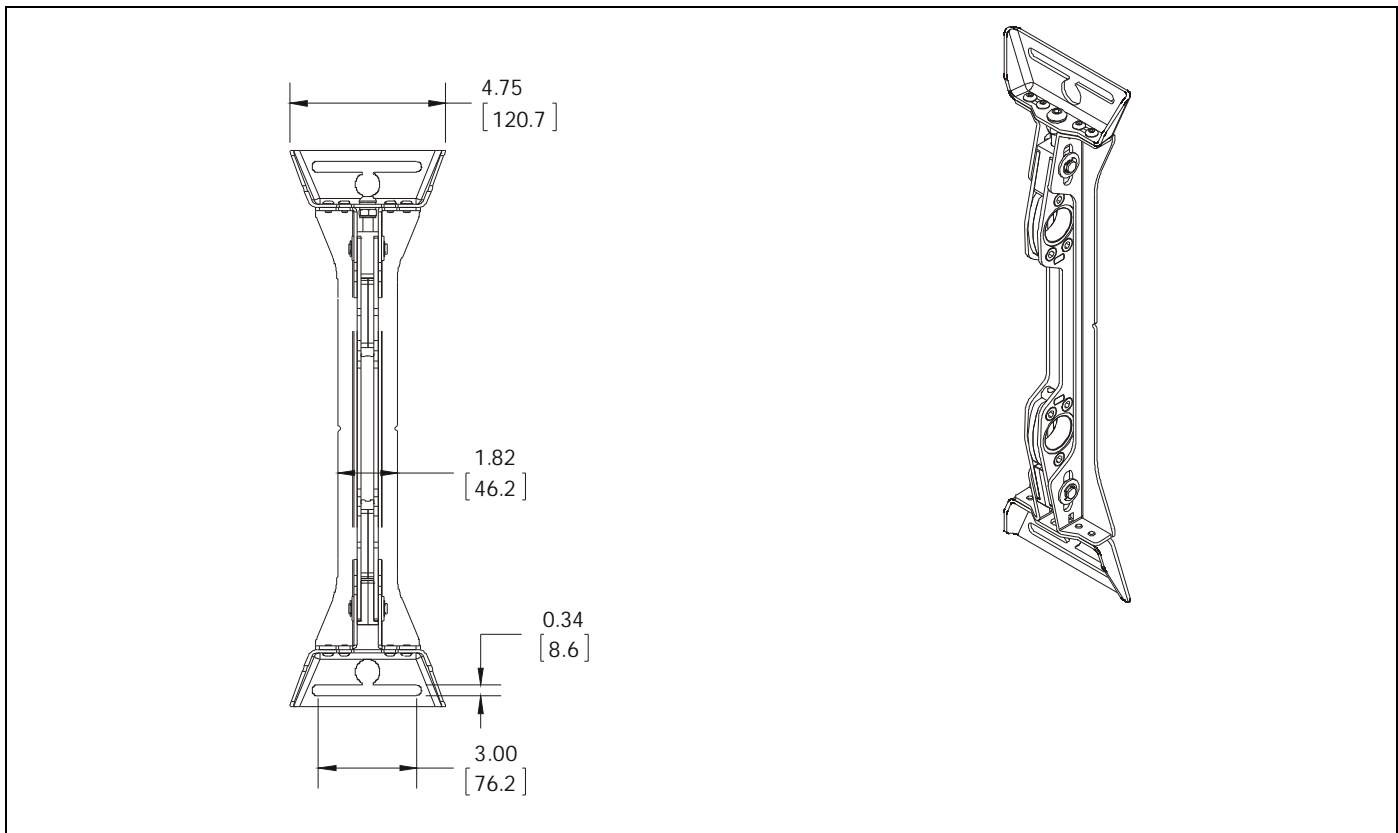

LEGEND

	<p>Tighten Fastener</p> <p>Apretar elemento de fijación</p> <p>Befestigungsteil festziehen</p> <p>Apertar fixador</p> <p>Serrare il fissaggio</p> <p>Bevestiging vastdraaien</p> <p>Serrez les fixations</p>		<p>Pencil Mark</p> <p>Marcar con lápiz</p> <p>Stiftmarkierung</p> <p>Marcar com lápis</p> <p>Segno a matita</p> <p>Potloodmerkten</p> <p>Marquage au crayon</p>
	<p>Loosen Fastener</p> <p>Aflojar elemento de fijación</p> <p>Befestigungsteil lösen</p> <p>Desapertar fixador</p> <p>Allentare il fissaggio</p> <p>Bevestiging losdraaien</p> <p>Desserrez les fixations</p>		<p>Drill Hole</p> <p>Perforar</p> <p>Bohrloch</p> <p>Fazer furo</p> <p>Praticare un foro</p> <p>Gat boren</p> <p>Percez un trou</p>
	<p>Phillips Screwdriver</p> <p>Destornillador Phillips</p> <p>Kreuzschlitzschraubendreher</p> <p>Chave de fendas Phillips</p> <p>Cacciavite a stella</p> <p>Kruiskopschroevendraaier</p> <p>Tournevis à pointe cruciforme</p>		<p>Adjust</p> <p>Ajustar</p> <p>Einstellen</p> <p>Ajustar</p> <p>Regolare</p> <p>Afstellen</p> <p>Ajuster</p>
	<p>Open-Ended Wrench</p> <p>Llave de boca</p> <p>Gabelschlüssel</p> <p>Chave de bocas</p> <p>Chiave a punte aperte</p> <p>Steeksleutel</p> <p>Clé à fourche</p>		<p>Remove</p> <p>Quitar</p> <p>Entfernen</p> <p>Remover</p> <p>Rimuovere</p> <p>Verwijderen</p> <p>Retirez</p>
	<p>By Hand</p> <p>A mano</p> <p>Von Hand</p> <p>Com a mão</p> <p>A mano</p> <p>Met de hand</p> <p>À la main</p>		<p>Optional</p> <p>Opcional</p> <p>Optional</p> <p>Opcional</p> <p>Opzionale</p> <p>Optie</p> <p>En option</p>
	<p>Hex-Head Wrench</p> <p>Llave de cabeza hexagonal</p> <p>Sechskantschlüssel</p> <p>Chave de cabeça sextavada</p> <p>Chiave esagonale</p> <p>Zeskantsleutel</p> <p>Clé à tête hexagonale</p>		<p>Security Wrench</p> <p>Llave de seguridad</p> <p>Sicherheitsschlüssel</p> <p>Chave de segurança</p> <p>Chiave di sicurezza</p> <p>Veiligheidsleutel</p> <p>Clé de sécurité</p>

TOOLS REQUIRED FOR INSTALLATION

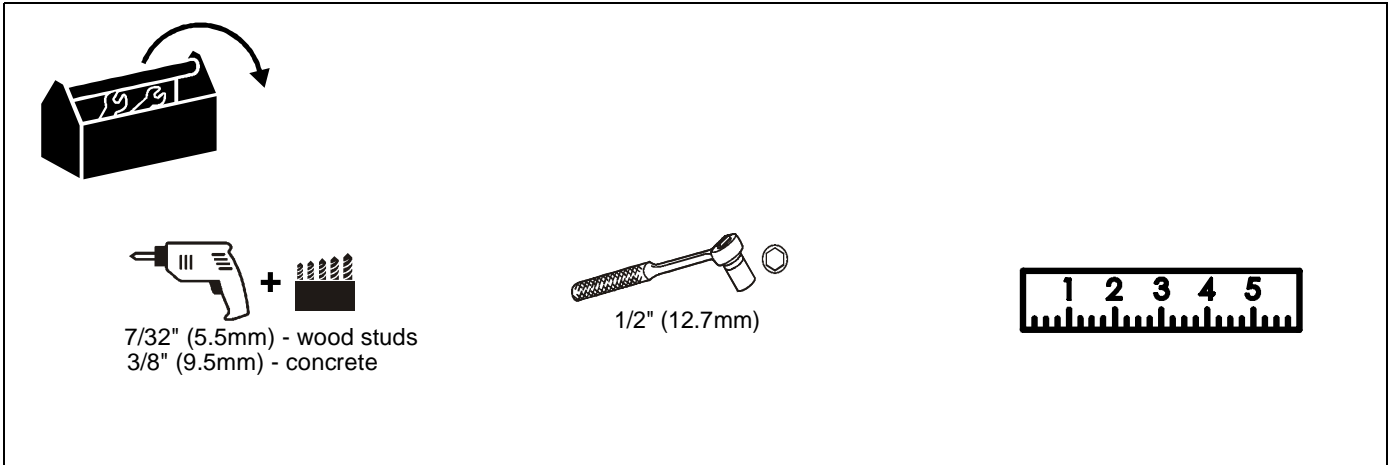

PARTS

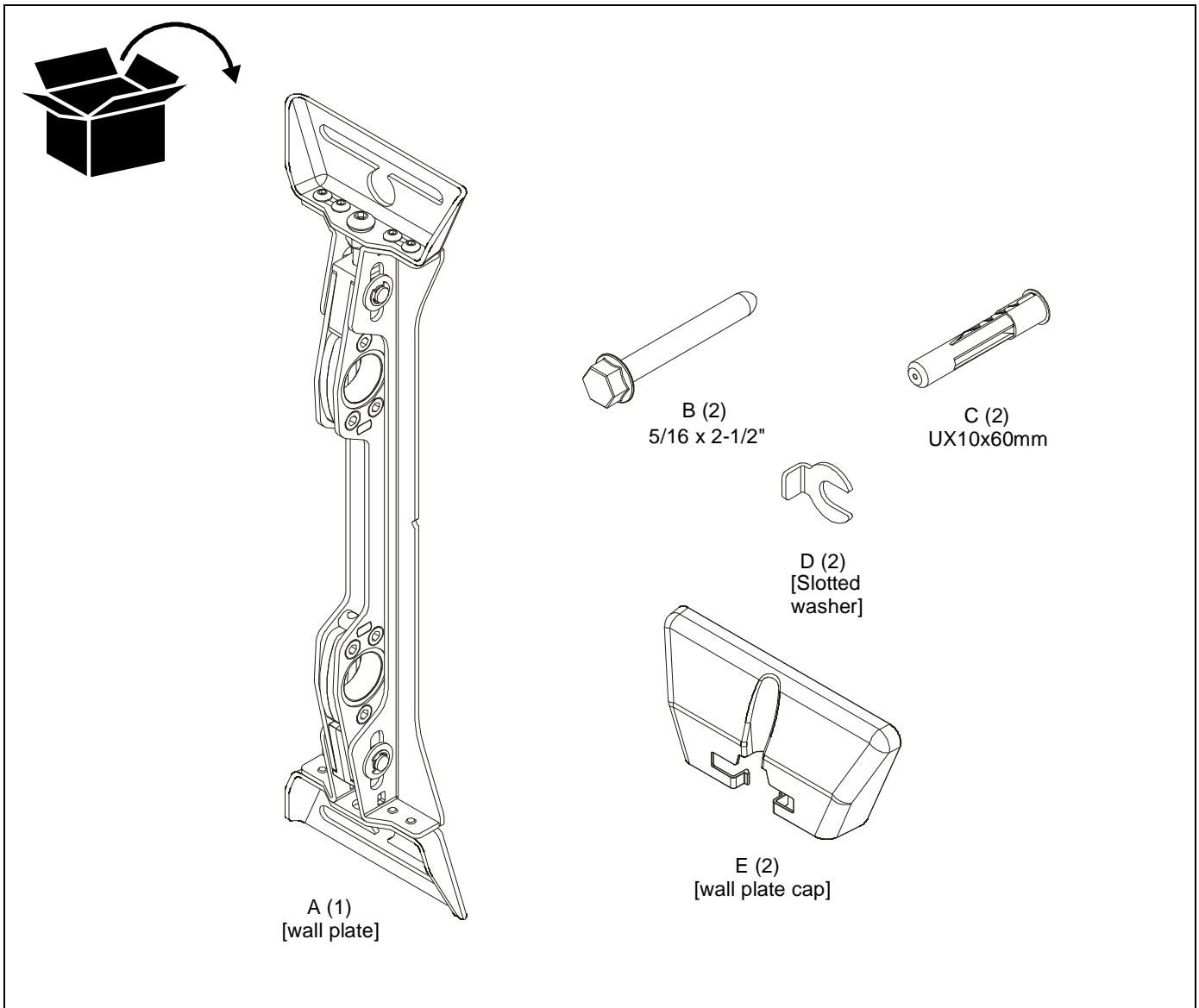

Assembly And Installation

Installing FCA115 Wall Plate to XTM1U/XSM1U Mount

1. Remove caps from one side of mounting rails on XTM1U/XSM1U mount. (See Figure 1)

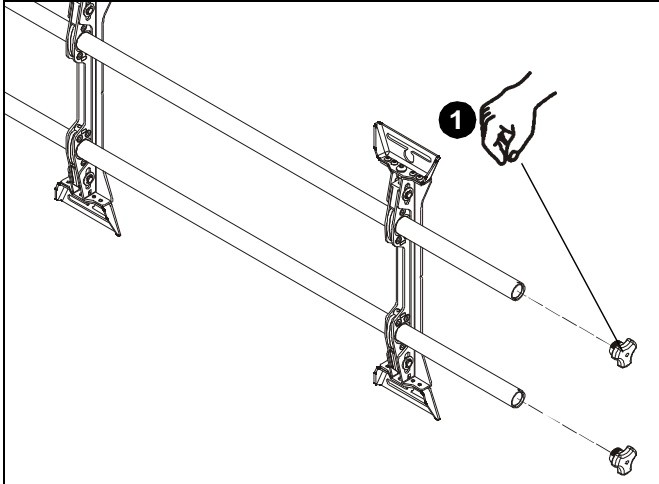

Figure 1

2. Slide FCA wall plate (A) onto XTM1U/XSM1U mount rails. (See Figure 2)
3. Reinstall caps onto mounting rails. (See Figure 2)

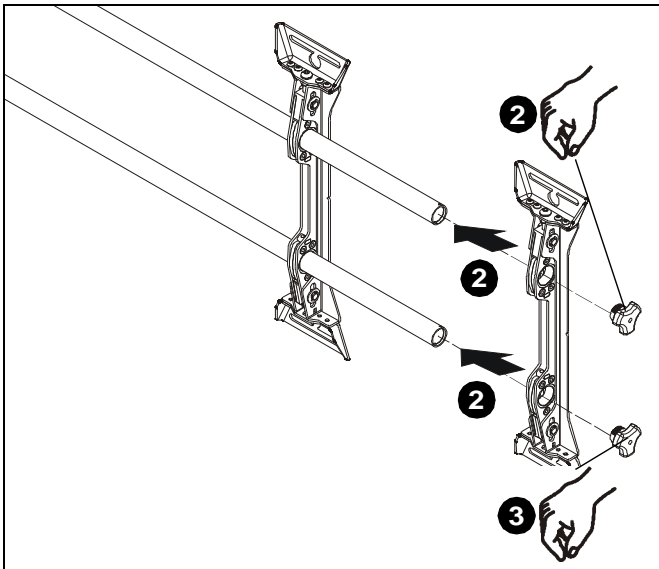

Figure 2

4. Position three wall plates 16" apart from each other on rails. (See Figure 3)

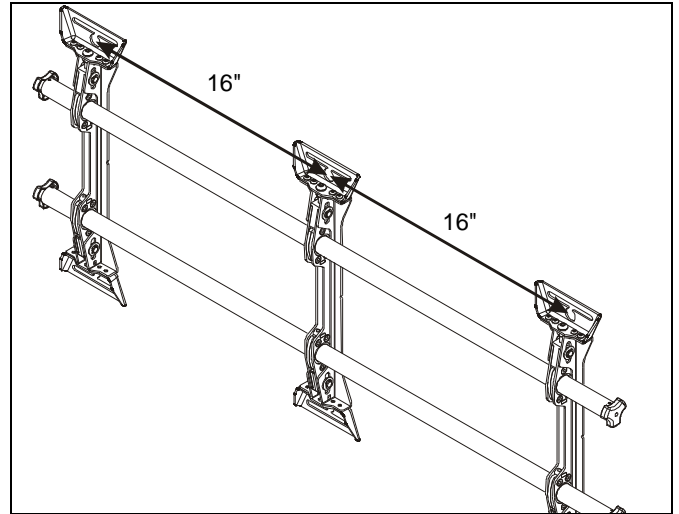

Figure 3

Installing to a Wood Stud Wall

1. Determine the center of the TV screen, and where it should be located on the wall.
2. Locate the closest stud to the selected location.

NOTE: Center of display should be located either directly over or near a stud.

3. Line up the notches on mount with center of screen marking to determine vertical center. (See Figure 4)
4. Measure up 8" (203mm) from the center point to mark location of the upper mounting slots.

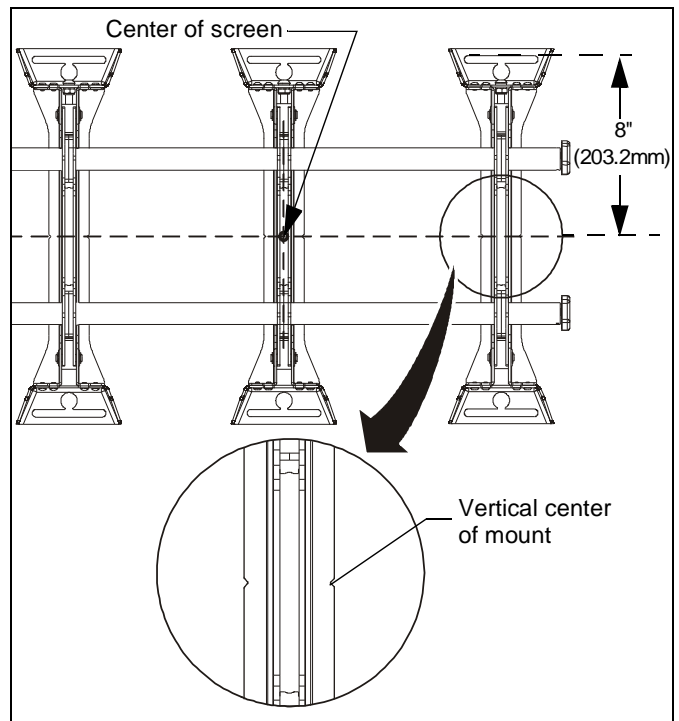

Figure 4

- Using a level, mark the wall on each stud to attach the mount through the upper mounting slots. (See Figure 5)
- Drill one 7/32" (5.5mm) pilot hole in each stud.
- Partially install three 5/16 x 2-1/2" flanged lag bolts (B) into pilot holes but do not tighten to wall.
- Hang mount, aligning upper mounting slots over lag bolts and adjust side-to-side for proper location.
- Place one slotted washer (D) over each flanged lag bolt. (See Figure 5)
- Tighten lag bolts to secure mount to wall at upper mounting slots.
- Mark the attachment points for the lower mounting slots, making sure the attachment points are located on the studs. (See Figure 5)
- Drill 7/32" (5.5mm) pilot holes at markings for lower mounting holes. (See Figure 5)
- Use three 5/16 x 2-1/2" flanged lag bolts (B) and two 5/16" slotted washers (D) to attach the mount to the wall through the lower mounting holes. (See Figure 5)
- Slide rails to approximate center of screen location.

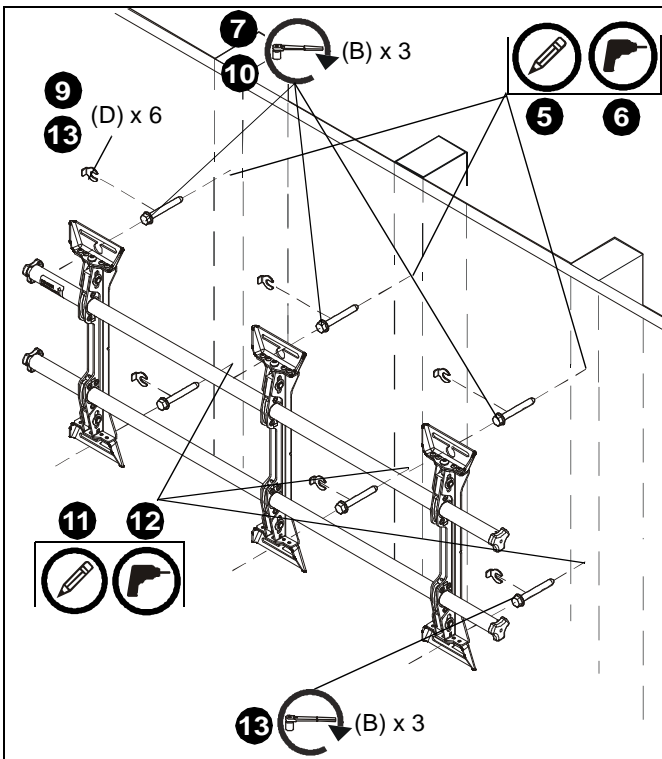

Figure 5

Installing to a Concrete Wall

- Determine the center of the TV screen, and where it should be located on the wall.
- Line up the notches on mount with center of screen marking to determine vertical center. (See Figure 6)
- Measure up 8" (203.2mm) from the center point to mark location of the upper mounting slots. (See Figure 6)
- Using a level, mark the wall through both upper mounting slots. (See Figure 6)

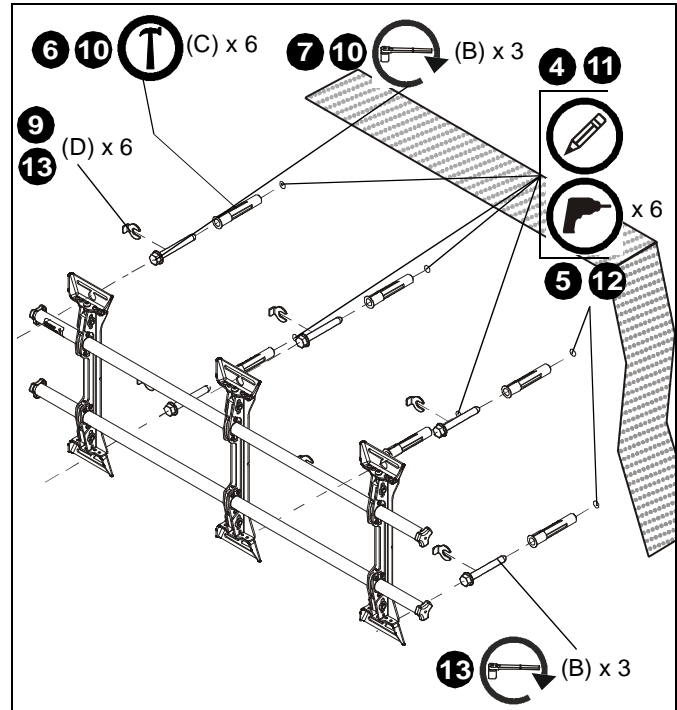

Figure 6

- Drill one 3/8" x 3-1/2" (9.5mm x 88.9mm) pilot hole at each marking. (See Figure 6)
- Install an anchor (C) into each pilot hole using a hammer, making sure that the anchor is flush with the wall. (See Figure 6)
- Partially install three 5/16 x 2-1/2" flanged lag bolts (B) into pilot holes but do not tighten to wall. (See Figure 6)
- Hang mount, aligning upper mounting slots over lag bolts and adjust side-to-side for proper location.
- Place one slotted washer (D) over each flanged lag bolt. (See Figure 6)
- Tighten lag bolts to secure mount to wall at upper mounting slots.
- Mark the attachment points for the lower mounting slots, making sure the attachment points are located on the studs. (See Figure 6)
- Drill 3/8" x 3-1/2" (9.5mm x 88.9mm) pilot holes at markings for lower mounting holes. (See Figure 6)
- Use three 5/16 x 2-1/2" flanged lag bolts (B) and two 5/16" slotted washers (D) to attach the mount to the wall through the lower mounting holes. (See Figure 6)
- Slide rails to approximate center of screen location.

See XSM1U/XTM1U Installation Instructions to complete installation.



Our Mounts. **Your Vision.**

Chief, a products division of
Milestone AV Technologies

8800-002782 Rev00
©2015 Milestone AV Technologies
www.chiefmfg.com
08/15

USA/International	A 6436 City West Parkway, Eden Prairie, MN 55344 P 800.582.6480 / 952.225.6000 F 877.894.6918 / 952.894.6918
Europe	A Franklinstraat 14, 6003 DK Weert, Netherlands P +31 (0) 495 580 852 F +31 (0) 495 580 845
Asia Pacific	A Office No. 1 on 12/F, Shatin Galleria 18-24 Shan Mei Street Fotan, Shatin, Hong Kong P 852 2145 4099 F 852 2145 4477

