

INSTALLATION INSTRUCTIONS

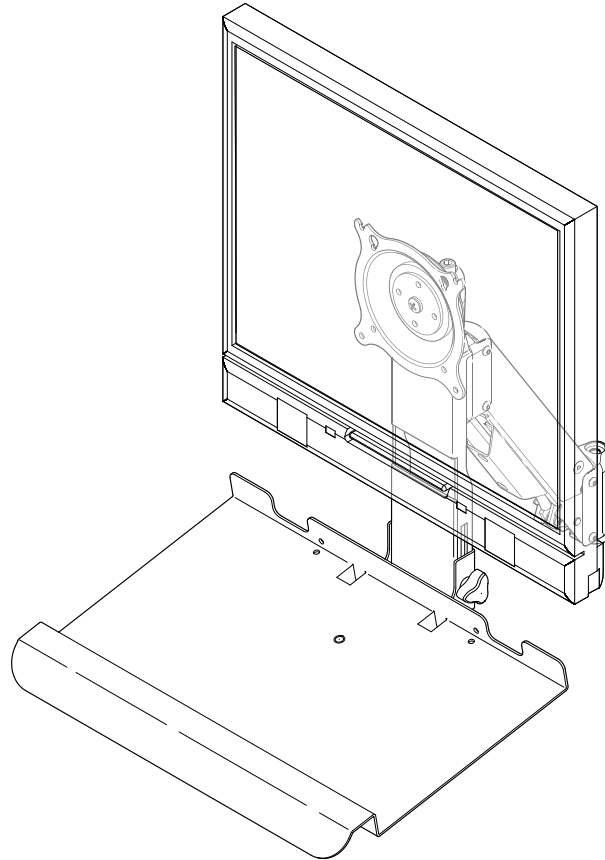

Keyboard Tray Accessory

DISCLAIMER

CSAV, Inc., and its affiliated corporations and subsidiaries (collectively, "CSAV"), intend to make this manual accurate and complete. However, CSAV makes no claim that the information contained herein covers all details, conditions or variations, nor does it provide for every possible contingency in connection with the installation or use of this product. The information contained in this document is subject to change without notice or obligation of any kind. CSAV makes no representation of warranty, expressed or implied, regarding the information contained herein. CSAV assumes no responsibility for accuracy, completeness or sufficiency of the information contained in this document.

! IMPORTANT WARNINGS AND CAUTIONS!

! WARNING: A WARNING alerts you to the possibility of serious injury or death if you do not follow the instructions.

! CAUTION: A CAUTION alerts you to the possibility of damage or destruction of equipment if you do not follow the corresponding instructions.

! WARNING: Failure to read, thoroughly understand, and follow all instructions can result in serious personal injury, damage to equipment, or voiding of factory warranty! It is the installer's responsibility to make sure all components are properly assembled and installed using the instructions provided.

! WARNING: Failure to provide adequate structural strength for this component can result in serious personal injury or damage to equipment! It is the installer's responsibility to make sure the structure to which this component is attached can support five times the combined weight of all equipment. Reinforce the structure as required before installing the component.

! WARNING: ADDING THIS ACCESSORY WILL DERATE YOUR MOUNT TO 20LBS (9KG). Exceeding the weight capacity of the mount can result in serious personal injury or damage to equipment! It is the installer's responsibility to make sure the combined weight of the display and any other device, such as a keyboard, being installed does not exceed 20lbs (9kg).

DIMENSIONS

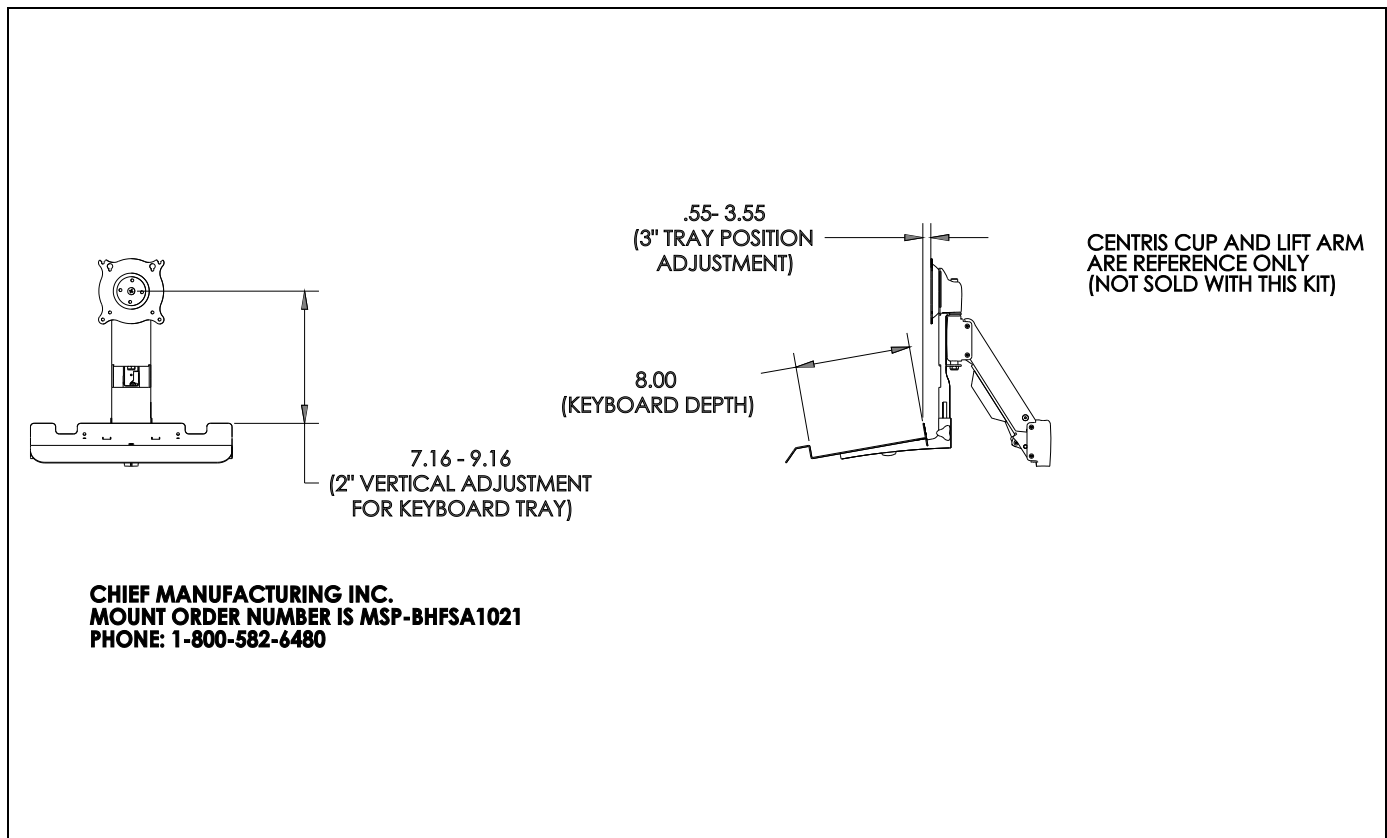

LEGEND

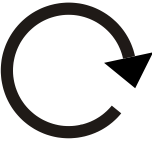
	Tighten Fastener
	Apretar elemento de fijación
	Befestigungsteil festziehen
	Apertar fixador
	Serrare il fissaggio
	Bevestiging vastdraaien
	Serrez les fixations
Сожмите Застежку	

	Hex-Head Wrench
	Llave de cabeza hexagonal
	Sechskantschlüssel
	Chave de cabeça sextavada
	Chiave esagonale
	Zeskantsleutel
	Clé à tête hexagonale
Ключ с шестигранной головкой	

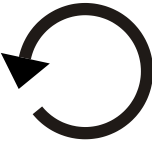
	Loosen Fastener
	Aflojar elemento de fijación
	Befestigungsteil lösen
	Desapertar fixador
	Allentare il fissaggio
	Bevestiging losdraaien
	Desserrez les fixations
Ослабьте Застежку	

TOOLS REQUIRED FOR INSTALLATION AND PARTS

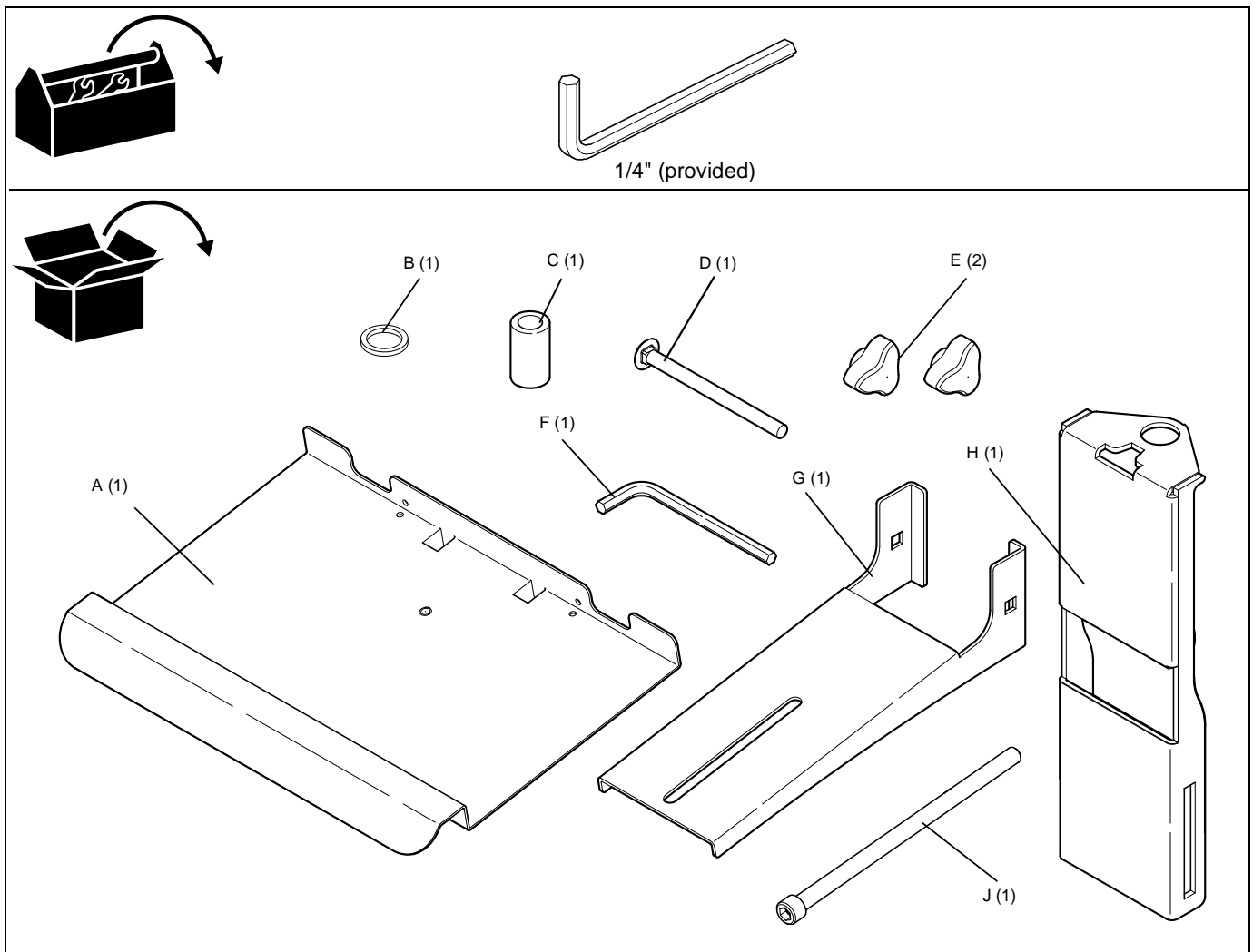

INSTALLATION



WARNING: IMPROPER INSTALLATION CAN LEAD TO MOUNT FALLING CAUSING SERIOUS PERSONAL INJURY OR DAMAGE TO EQUIPMENT! DO NOT substitute hardware. Only use hardware provided or specified by manufacturer.

1. Remove hardware securing Centris head assembly to height adjustable arm.
 2. Set hardware aside for re-use.
- IMPORTANT ! : DO NOT DISCARD HARDWARE!**
Hardware will be used when installing laptop tray accessory.
3. Orient vertical tray mounting bracket as show in figure below. (See Figure 1)
 4. Slide spacer (C) into bottom of height adjustable arm.
 5. Place UHM washer (B) on upper area of height adjustable arm.

6. Slide height adjustable arm with spacer and UHM washer (B) in between mounting tabs in vertical tray mounting bracket (H) until mounting holes in arm and bracket align. (See Figure 1)
7. Place UHM washer, removed during step 1, over mounting hole in upper mounting tab of vertical tray mounting bracket (H).
8. Slide spacer, removed during step 1, down through UHM washer and mounting hole in vertical tray mounting bracket (H) and into height adjustable arm. (See Figure 1)
9. Place two flat washers and one Nylon washer, removed during step 1, onto socket head screw (J) provided with tray accessory. (See Figure 1)
10. Align mounting hole in Centris head assembly with mounting hole in vertical tray mounting bracket (H).
11. Slide socket head screw (J) with washers down through Centris head assembly and height adjustable arm.
12. Hold hex nut, removed during step 1, in bottom of height adjustable arm and secure Centris head assembly and vertical tray mounting bracket (H) to height adjustable arm by tightening socket head screw (J) using 1/4" hex wrench.

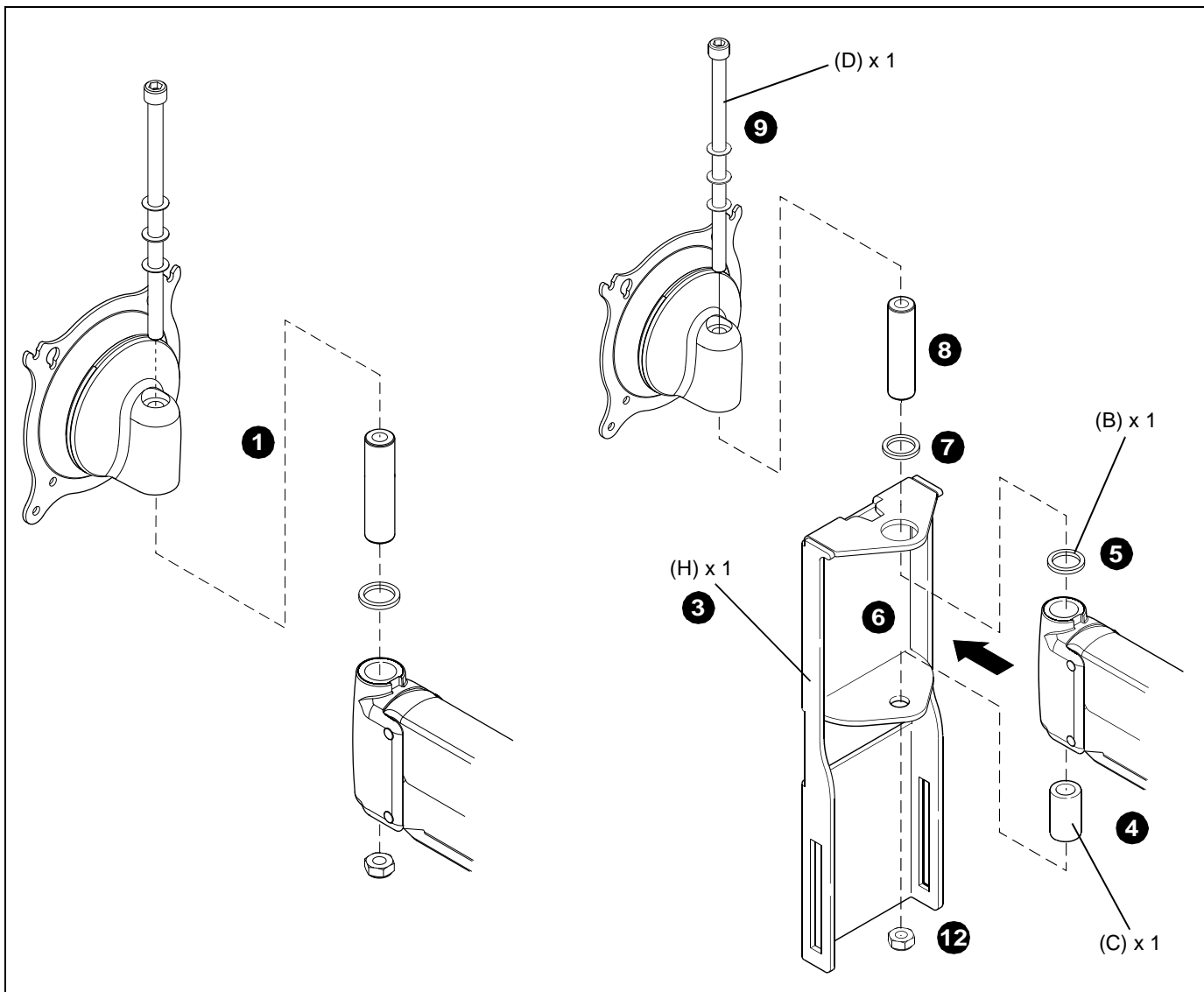

Figure 1

13. Orient horizontal tray mounting bracket (G) as shown in figure below. (See Figure 2)
14. Secure horizontal tray mounting bracket (G) to vertical tray mounting bracket (H) using one carriage bolt (J) and one knob (E). (See Figure 2)

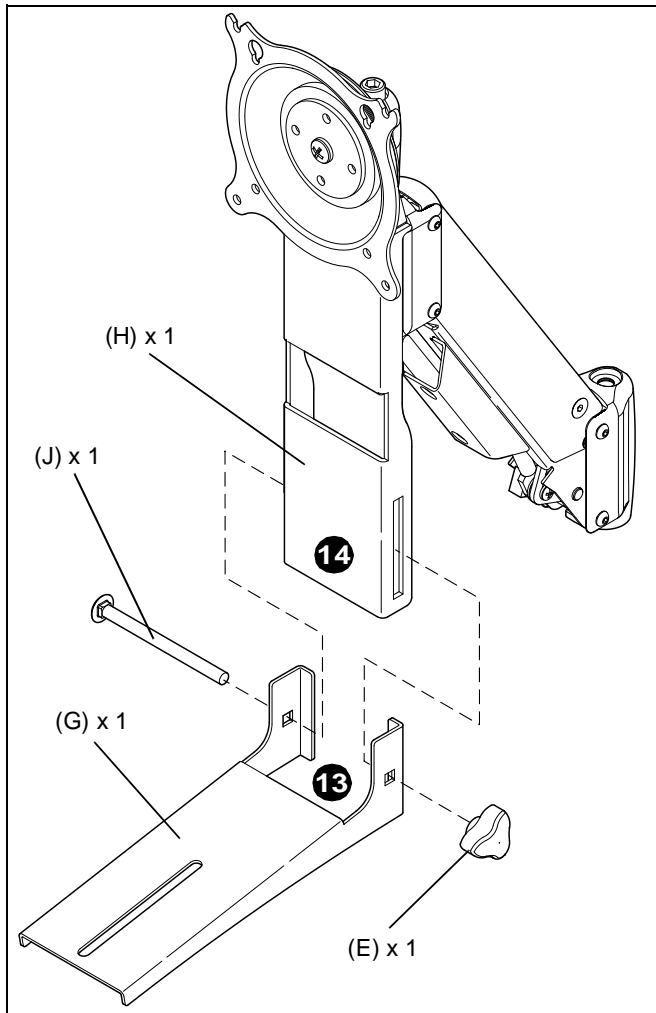

Figure 2

15. Orient tray (A) as shown. (See Figure 3)
16. Secure tray (A) to horizontal tray mounting bracket (G) using one knob (E). (See Figure 3)

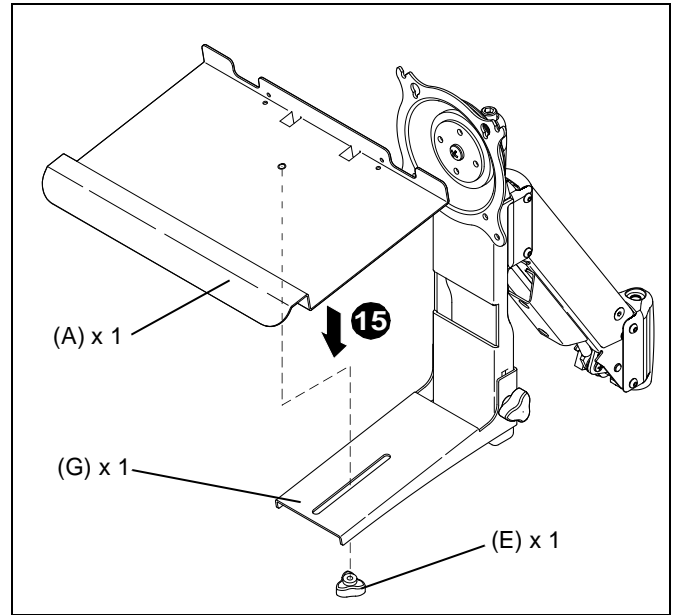

Figure 3



8807-000063
©2007 Chief Manufacturing
www.chiefmfg.com
04/07

USA/International	A 8401 Eagle Creek Parkway, Savage, MN 55378 P 800.582.6480 / 952.894.6280 F 877.894.6918 / 952.894.6918
Europe	A Fellenoord 130 5611 ZB EINDHOVEN, The Netherlands P +31 40 2668620 F +31 (0) 40 2668615
Asia Pacific	A Room 30I, Block D, Lily YinDu International Building LuoGang, BuJi Town, Shenzhen, CHINA. Post Code: 518112 深圳市布吉罗岗百合银都国际大厦D栋30I P +86-755-8996 9226 ; 8996 9236 ; 8996 9220 F +86-755-8996 9217