

INSTALLATION INSTRUCTIONS

MSB-6305 DISPLAY MOUNTING BRACKET

Prior to assembly, unpack carton completely and verify contents.

If you are missing any of the following components, please contact Customer Service at 1-800/582-6480

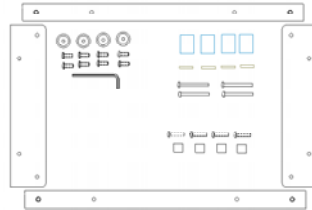

Figure 1

- (2) Interface Side Brackets
- (4) Mounting Buttons – Tapped
- (4) M4 x 40mm Phillips Head Cap Screws
- (4) .75 x .32 x .125 Nylon Spacers
- (4) .50 x .194 x .50 Nylon Spacers

- (2) Interface Center Brackets
- (8) 10-24 x .5 Button Head Cap Screws
- (4) .74 x .39 x 1.0 Nylon Spacers
- (4) M4 x 20mm Phillips Head Cap Screws
- 1) 1/8" Allen Key

BEFORE PROCEEDING, READ INSTALLATION INSTRUCTIONS COMPLETELY

CAUTION! **DISPLAYS ARE EXTREMELY FRAGILE.**

WARNING! **ALL COMPONENTS MUST BE SECURELY FASTENED TO A STRUCTURAL MEMBER CAPABLE OF SUPPORTING 4 TIMES THE COMBINED WEIGHT OF ALL COMPONENTS PLUS THE EQUIPMENT BEING MOUNTED. IF IT CANNOT SUPPORT THIS WEIGHT, THE STRUCTURE MUST BE REINFORCED. THE MAXIMUM WEIGHT TO BE INSTALLED ON THE INTERFACE IS 125 POUNDS (79.38 KG).**

NOTE: If installing screen on a Chief J-series wall mount, proceed to Step 3 (J-Series VESA Interface Installation).

1. **Chief Q-latch Button Installation (Used with MSR, MTR, MWH, MWR, MCS and MCD mounts):**
Using a 10-24 button head cap screw inserted from back side of bracket, secure mounting button, with chamfered hole of mounting button (larger surface) facing bracket, to center brackets (four places) (see Figure 2 & Figure3).
2. Proceed to Step 4 (Side Bracket Assembly).

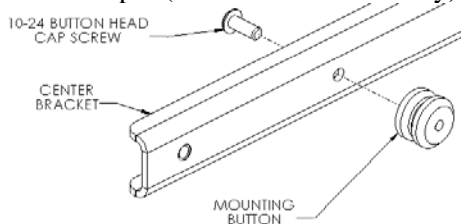

Figure 2

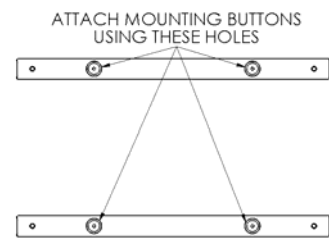

Figure 3

3. **J-Series VESA Interface Installation:** Using the 10-24 button head cap screws along with the 10-24 Nylock nuts (provided with J-Series mount), attach VESA interface from J-Series mount to center brackets (see Figure 4 & Figure 5).

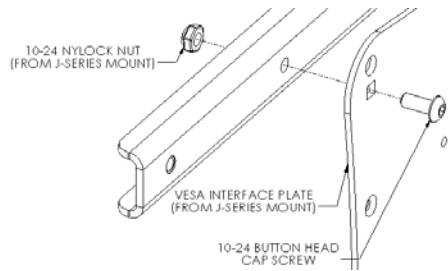

Figure 4

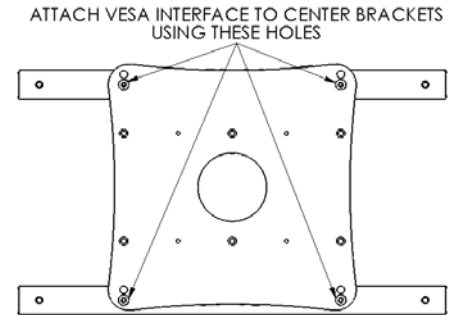

Figure 5

4. **Side Bracket Assembly:** Attach center brackets to side brackets using the 10-24 button head cap screws (see Figure 6 & Figure 7).

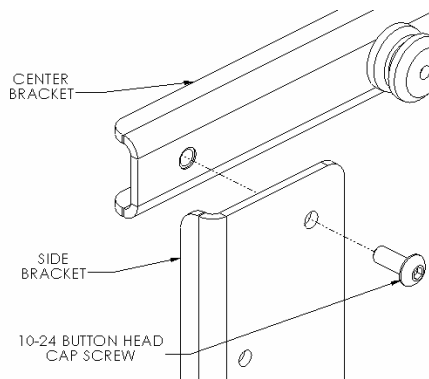

Figure 6

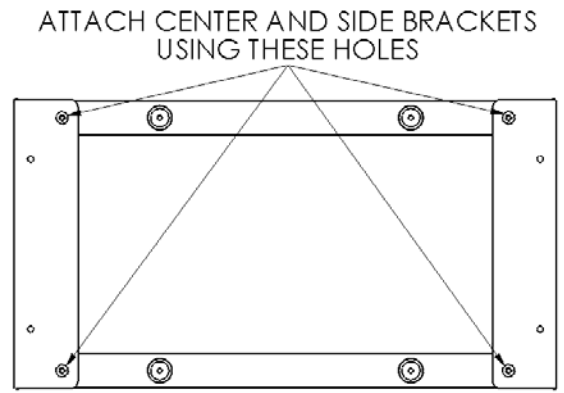

Figure 7

5. **Bracket Installation for screens having a tuner or protrusion on back:** Stack both 1" and .125" nylon spacers over mounting holes of screen and attach brackets to back of display using the M4 x 40mm screws (see Figure 8 & Figure 9). Do not over tighten screws.
6. **Bracket Installation for screens having a flat back:** Place .5" nylon spacers over mounting holes and attach brackets to back of display using the M4 x 20mm screws (see Figure 9 & Figure 10). Do not over tighten screws.
7. Follow the Chief mount instruction manual for screen installation.

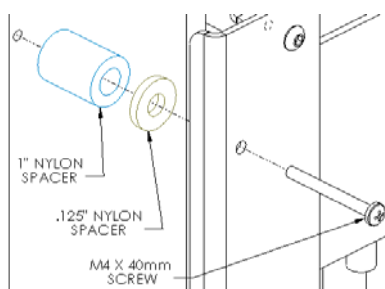

Figure 8
FOR SCREENS WITH TUNER
OR PROTRUSION ON BACK

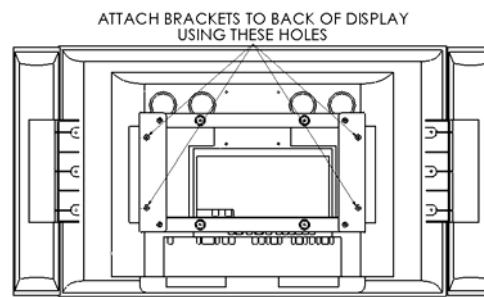

Figure 9

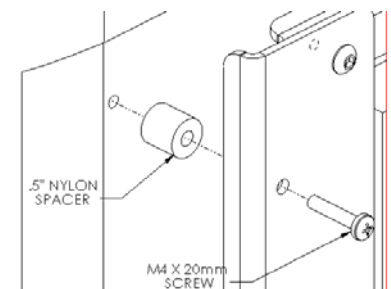

Figure 10
FOR SCREENS WITH FLAT BACK