

INSTALLATION INSTRUCTIONS

MSB-6641 DISPLAY MOUNTING BRACKET

Prior to assembly, unpack carton completely and verify contents.

If you are missing any of the following components, please contact Customer Service at 1-800/582-6480

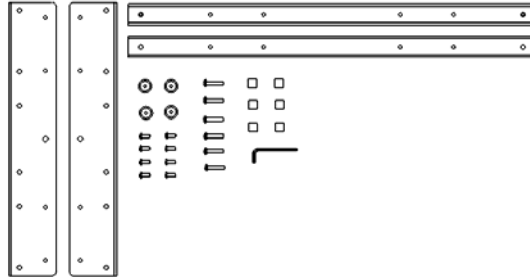

Figure 1

(2) Interface Side Brackets
(4) Mounting Buttons – Tapped
(6) M5 x 25mm Phillips Head Cap Screws
(1) 1/8" Allen Key

(2) Interface Center Brackets
(8) 10-24 x .500 Button Head Cap Screws
(6) .500 x .316 x .500 Nylon Spacers

BEFORE PROCEEDING, READ INSTALLATION INSTRUCTIONS COMPLETELY

CAUTION! DISPLAYS ARE EXTREMELY FRAGILE.

NOTE: If installing screen on a Chief J-series wall mount, proceed to Step 3 (J-Series VESA Interface Installation).

- Chief Q-latch Button Installation (Used with MSR, MTR, MWH, MWR, MCS and MCD mounts):**
Using a 10-24 button head cap screw inserted from back side of bracket, secure mounting button, with chamfered hole of mounting button (larger surface) facing bracket, to center brackets (four places) (see Figure 2 & Figure3).
- Proceed to Step 4 (Side Bracket Assembly).

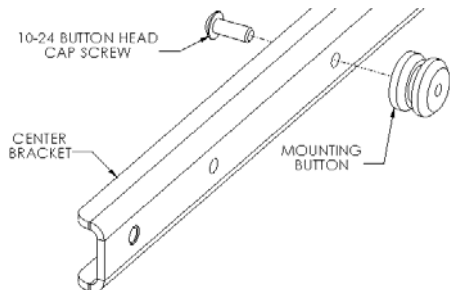

Figure 2

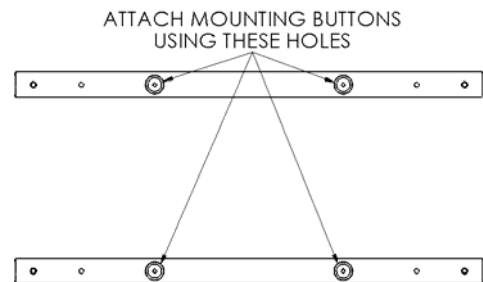

Figure 3

3. **J-Series VESA Interface Installation:** Using the 10-24 button head cap screws along with the 10-24 Nylock nuts (provided with J-Series mount), attach VESA interface from J-Series mount to center brackets (see Figure 4 & Figure 5).

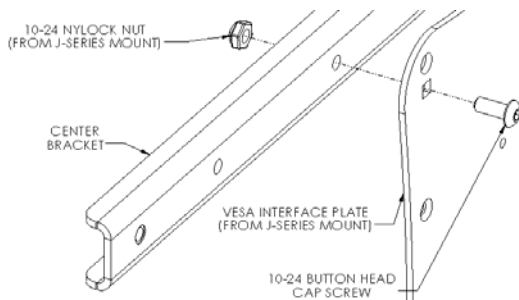

Figure 4

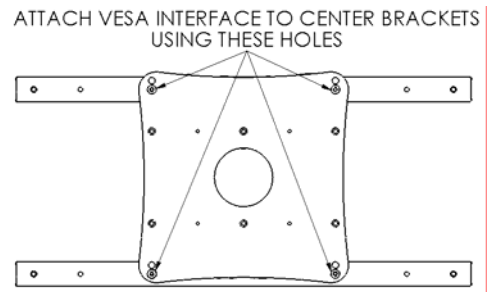

Figure 5

4. **Side Bracket Assembly:** Attach center brackets to side brackets using the 10-24 button head cap screws (see Figure 6 & Figure 7).

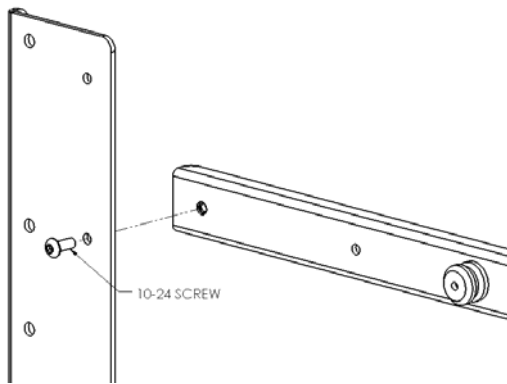

Figure 6

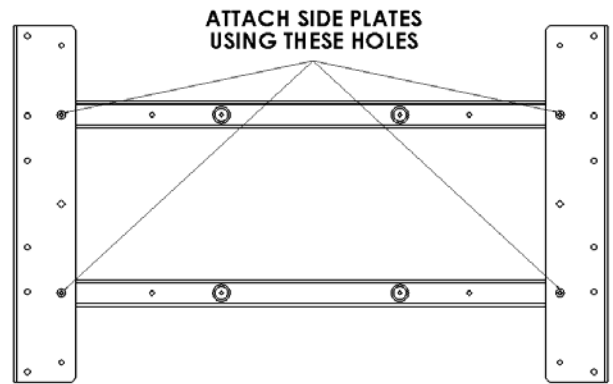

Figure 7

5. **Bracket Installation:** Place nylon spacers over mounting holes of screen and attach brackets to back of display using the M5 screws (see Figure 8 & Figure 9). Do not over tighten screws.

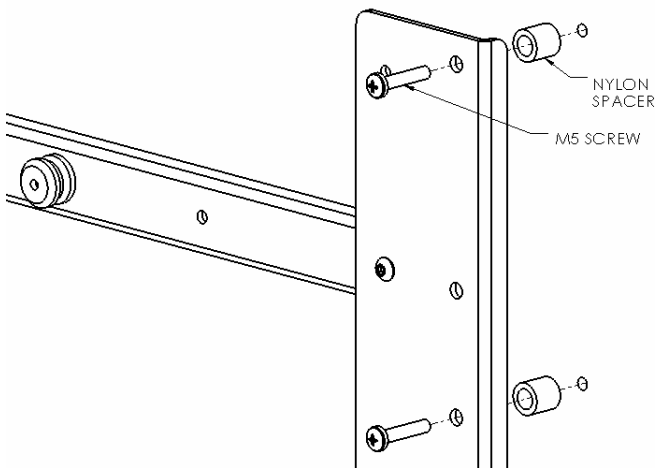

Figure 8

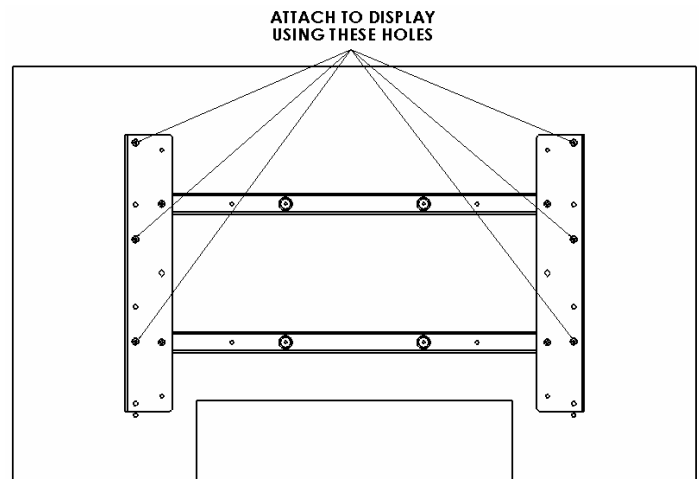

Figure 9

6. Follow the Chief mount instruction manual for screen installation.