

INSTALLATION INSTRUCTIONS

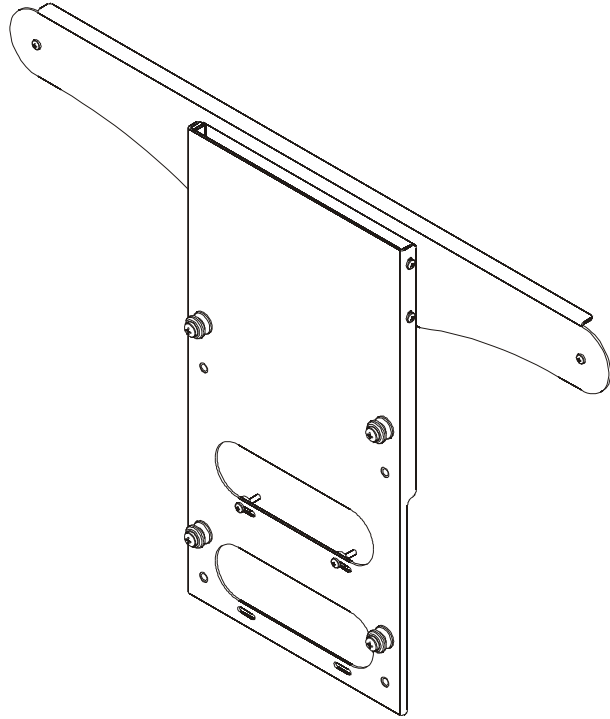

Custom Interface Bracket

DISCLAIMER

Milestone AV Technologies and its affiliated corporations and subsidiaries (collectively "Milestone"), intend to make this manual accurate and complete. However, Milestone makes no claim that the information contained herein covers all details, conditions or variations, nor does it provide for every possible contingency in connection with the installation or use of this product. The information contained in this document is subject to change without notice or obligation of any kind. Milestone makes no representation of warranty, expressed or implied, regarding the information contained herein. Milestone assumes no responsibility for accuracy, completeness or sufficiency of the information contained in this document.

Chief® is a registered trademark of Milestone AV Technologies. All rights reserved.

! IMPORTANT WARNINGS AND CAUTIONS!

! WARNING: A WARNING alerts you to the possibility of serious injury or death if you do not follow the instructions.

! CAUTION: A CAUTION alerts you to the possibility of damage or destruction of equipment if you do not follow the corresponding instructions.

! WARNING: Failure to read, thoroughly understand, and follow all instructions can result in serious personal injury, damage to equipment, or voiding of factory warranty! It is the installer's responsibility to make sure all components are properly assembled and installed using the instructions provided.

! WARNING: Failure to provide adequate structural strength for this component can result in serious personal injury or damage to equipment! It is the installer's responsibility to make sure the structure to which this component is attached can support five times the combined weight of all equipment. Reinforce the structure as required before installing the component. The wall to which the mount is being attached may have a maximum drywall thickness of 5/8" (1.6cm).

! WARNING: Exceeding the weight capacity can result in serious personal injury or damage to equipment! It is the installer's responsibility to make sure the maximum weight installed on the interface bracket doesn't exceed 50 lbs (22.68 kg).

DIMENSIONS

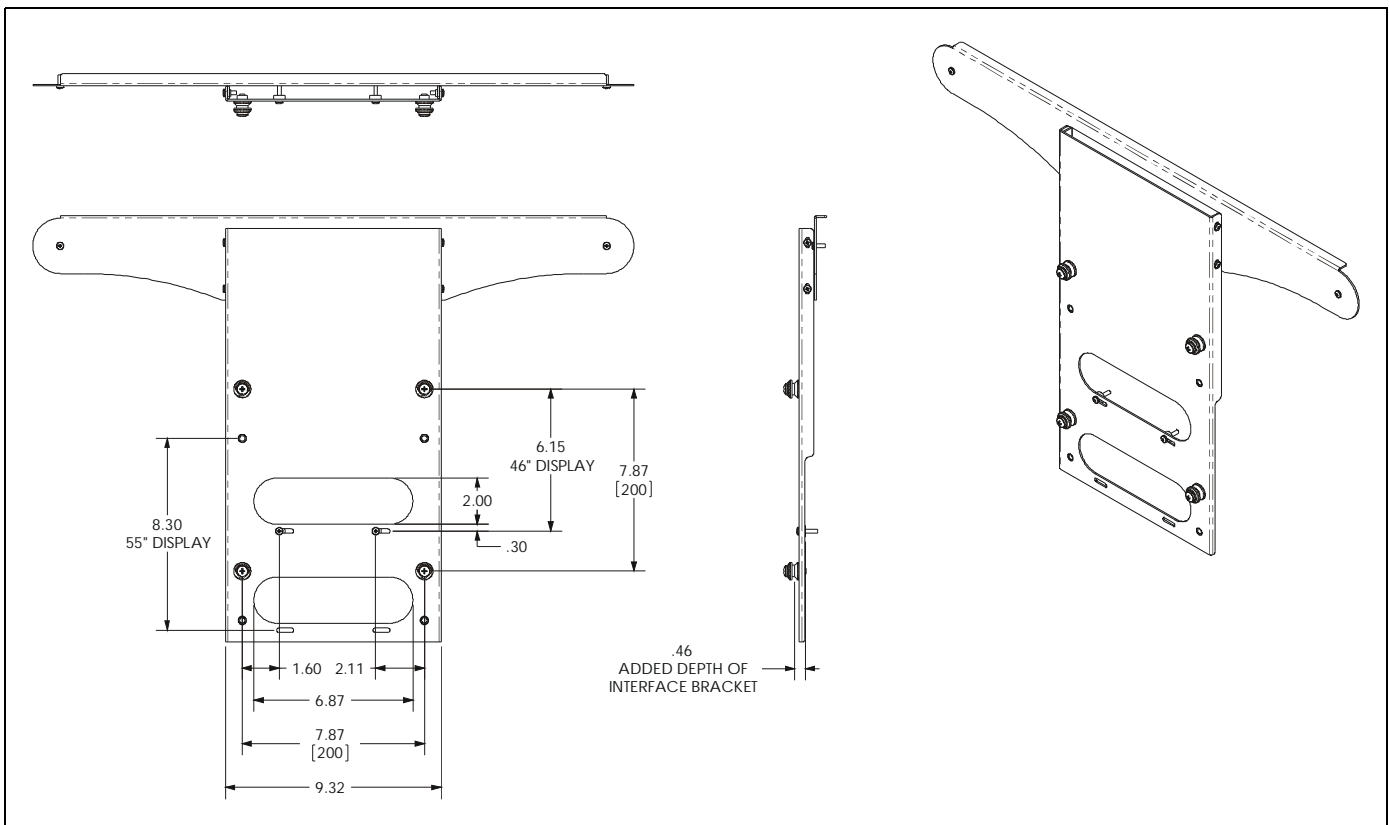

TOOLS / PARTS FOR INSTALLATION

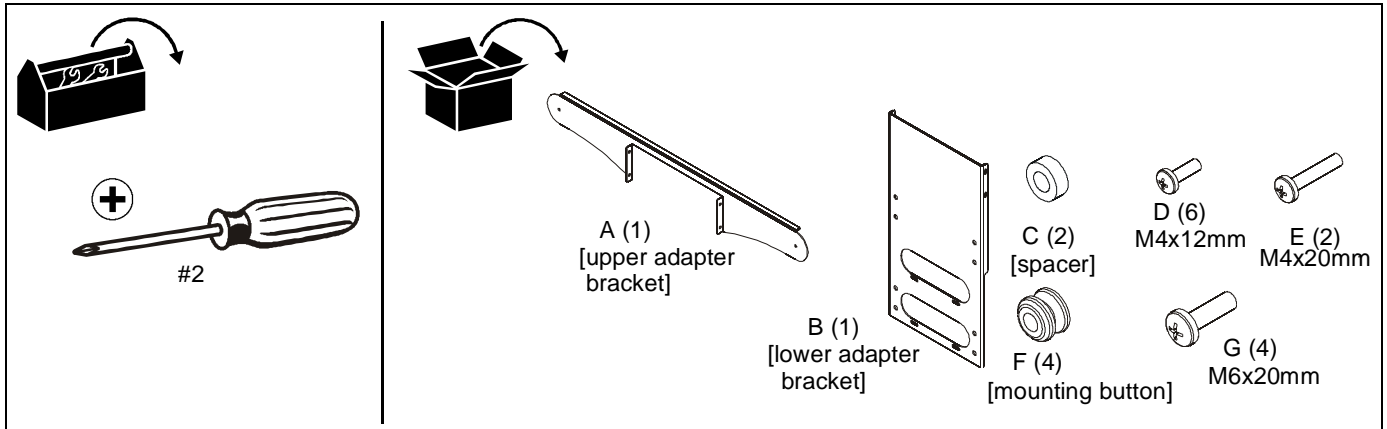

ASSEMBLY AND INSTALLATION

1. Prepare display for wall mounting according to instructions included with display and lay display face down on a soft, non-abrasive surface.

NOTE: Top center screws holding connector panel to display must be removed prior to installing interface to display.

2. Loosely attach upper adapter bracket (A) to lower adapter bracket (B) using four M4x12mm Phillips pan machine screws (D). (See Figure 1)

NOTE: DO NOT tighten screws at this point in order to allow for some variance when installing lower screws.

3. Attach upper adapter bracket (A) to display using two M4x12mm Phillips pan machine screws (D). (See Figure 1)

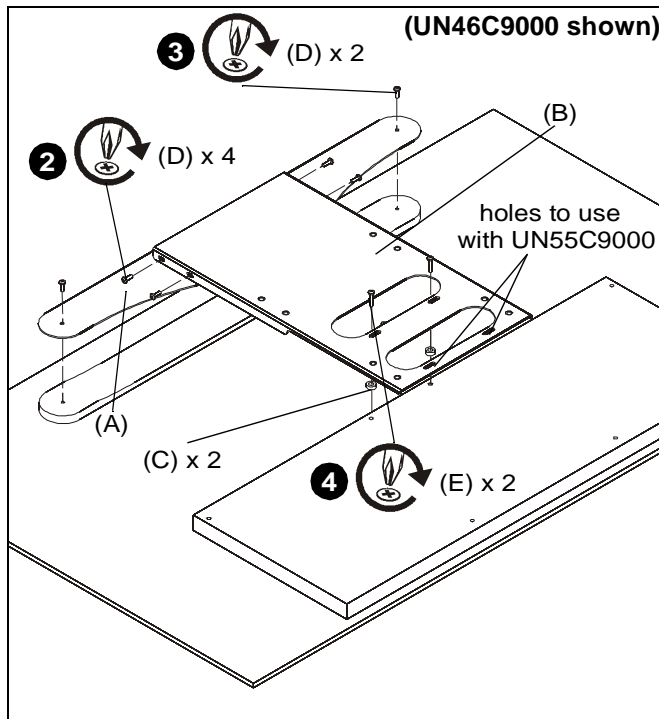

Figure 1

4. Attach lower adapter bracket (B) to display using two M4x20mm Phillips pan machine screws (E) and two

spacers (C). (See Figure 1)

IMPORTANT ! : If installing UN55C9000 display, the lower two holes must be used to attach lower adapter bracket to display.

5. Tighten all screws to fully secure bracket to display.
6. Attach four mounting buttons to lower adapter bracket using four M6x20mm Phillips pan machine screws (G). (See Figure 2)

IMPORTANT ! : If installing UN55C9000 display, the lower four holes must be used to attach mounting buttons in order to achieve a centered mount!

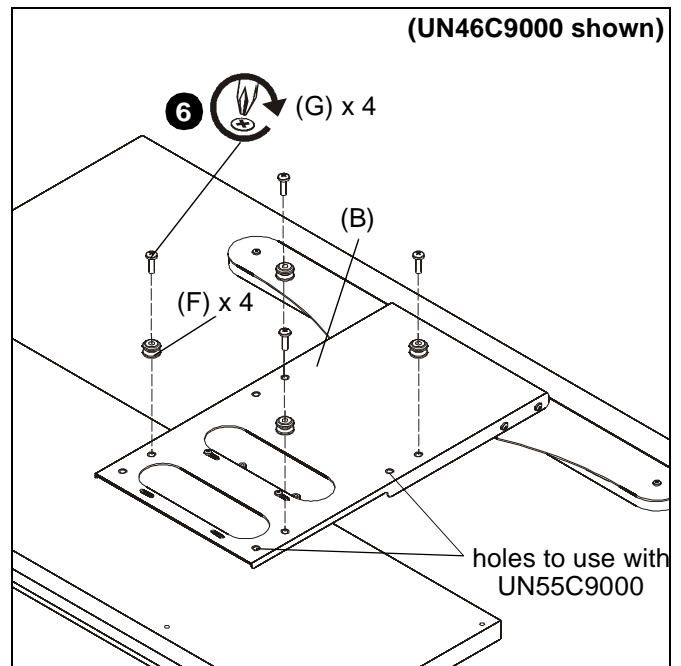

Figure 2

7. Complete the installation following the mount installation instructions.



Our Mounts. **Your Vision.**

Chief Manufacturing, a products division
of Milestone AV Technologies

8800-002074 Rev00
©2011 Milestone AV Technologies, a
Duchossois Group Company
www.chiefmfg.com
02/11

USA/International	A 8401 Eagle Creek Parkway, Savage, MN 55378 P 800.582.6480 / 952.894.6280 F 877.894.6918 / 952.894.6918
Europe	A Fellenoord 130 5611 ZB EINDHOVEN, The Netherlands P +31 (0)40 2668620 F +31 (0)40 2668615
Asia Pacific	A Office No. 1 on 12/F, Shatin Galleria 18-24 Shan Mei Street Fotan, Shatin, Hong Kong P 852 2145 4099 F 852 2145 4477

