

---

# INSTALLATION INSTRUCTIONS

---

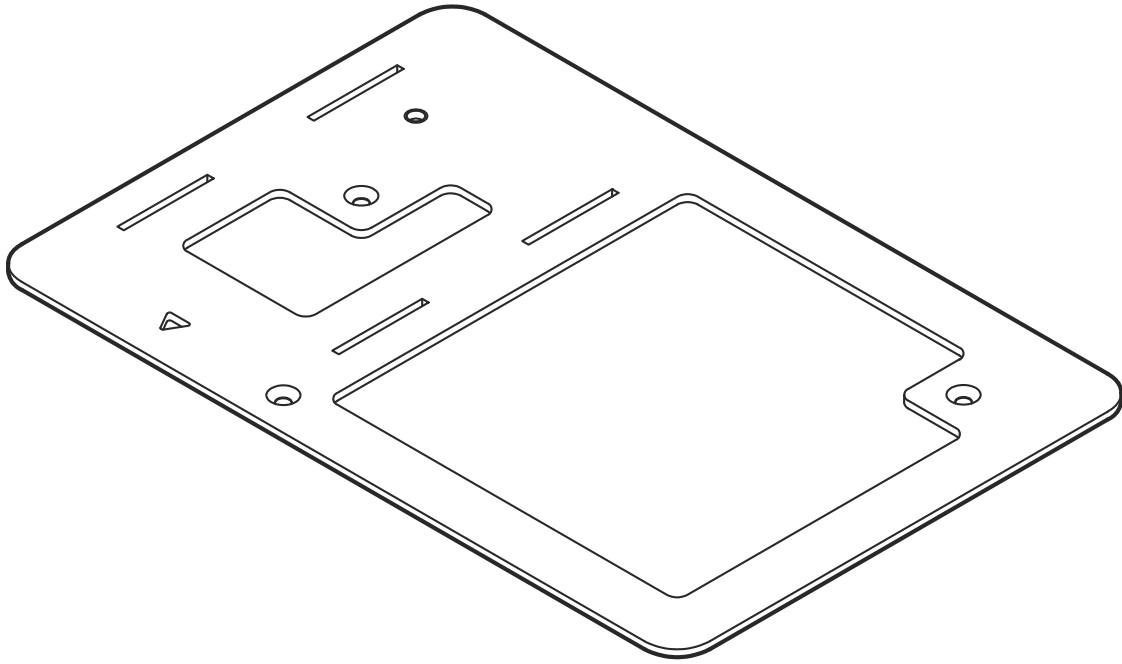

---

**Retrofit Adapter Bracket**

---

---

***InFocus***

**INA-SMARTADPT**

---

**DISCLAIMER**

Milestone AV Technologies and its affiliated corporations and subsidiaries (collectively “Milestone”), intend to make this manual accurate and complete. However, Milestone makes no claim that the information contained herein covers all details, conditions or variations, nor does it provide for every possible contingency in connection with the installation or use of this product. The information contained in this document is subject to change without notice or obligation of any kind. Milestone makes no representation of warranty, expressed or implied, regarding the information contained herein. Milestone assumes no responsibility for accuracy, completeness or sufficiency of the information contained in this document.

Chief® is a registered trademark of Milestone AV Technologies. All rights reserved.

SMART Board® is a registered trademark of SMART Technologies.

 **IMPORTANT SAFETY INSTRUCTIONS**

 **WARNING:** A WARNING alerts you to the possibility of serious injury or death if you do not follow the instructions.

 **CAUTION:** A CAUTION alerts you to the possibility of damage or destruction of equipment if you do not follow the corresponding instructions.

 **WARNING:** Failure to read, thoroughly understand, and follow all instructions can result in serious personal injury, damage to equipment, or voiding of factory warranty! It is the installer’s responsibility to make sure all components are properly assembled and installed using the instructions provided.

 **WARNING:** Failure to provide adequate structural strength for this component can result in serious personal injury or damage to equipment! It is the installer’s responsibility to verify the structure to which the existing SMART projector mount is attached can support five times the combined weight of all equipment. In addition, the installer is responsible to verify the existing SMART projector mount was installed according to the manufacturer’s requirements and is undamaged.

 **WARNING:** Exceeding the weight capacity can result in serious personal injury or damage to equipment! It is the installer’s responsibility to make sure the weight of the projector attached to the INA-SMARTADPT does not exceed 7 lbs (3.2 kg).

 **WARNING:** Use this mounting system only for its intended use as described in these instructions. Do not use attachments not recommended by the manufacturer.

 **WARNING:** Never operate this mounting system if it is damaged. Return the mounting system to a service center for examination and repair.

 **WARNING:** Do not use this product outdoors.

**IMPORTANT ! :** The INA-SMARTADPT brackets are designed to be attached **ONLY** to the IN126STa projector (listed in Table 1) which is replacing existing SMART UF55, UF55W, UF65, and UF65W projectors used **ONLY** with SMART Board® Models SB660, SB680, SB880, SB685, or SB885 as listed in Table 1.

**Table 1: Projector / SMART Board Information**



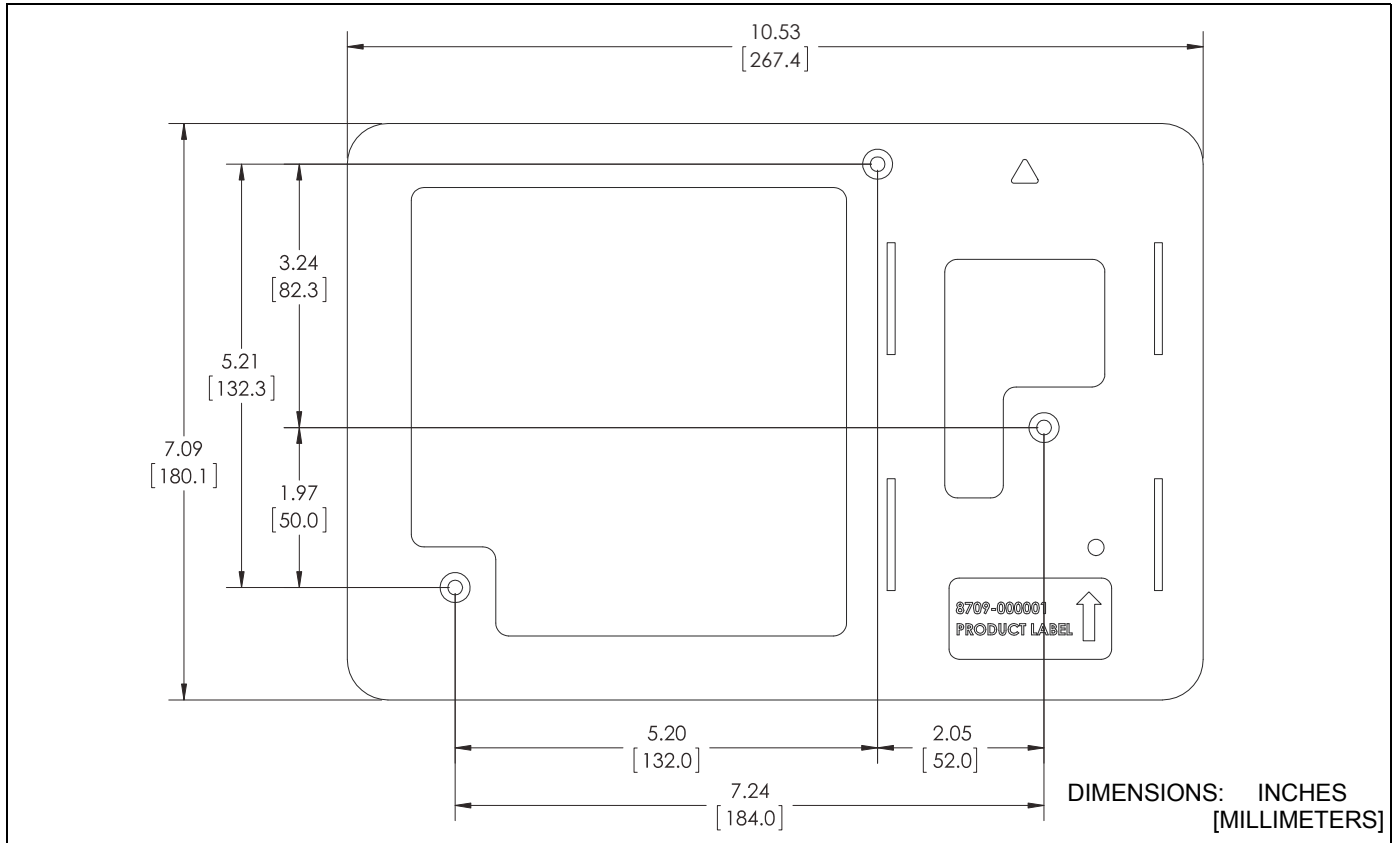

Mfr	Proj Model	Proj Wt (lbs)	Native Proj. Aspect Ratio	SMART Board Models (i3 and i4 Series)		
				SB660	SB680 SB880	SB685 SB885
InFocus	IN126STa	7	16:10	(4.3)	(4.3)	(16.10)
				X	X	X

**--SAVE THESE INSTRUCTIONS--**

**DIMENSIONS**

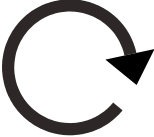

**LEGEND**

	<b>Tighten Fastener</b>		<b>Security Wrench</b>
	Apretar elemento de fijación		Llave de seguridad
	Befestigungsteil festziehen		Sicherheitsschlüssel
	Apertar fixador		Chave de segurança
	Serrare il fissaggio		Chiave di sicurezza
	Bevestiging vastdraaien		Veiligheidssleutel
Serrez les fixations	Clé de sécurité		
	<b>Loosen Fastener</b>		<b>Adjust</b>
	Aflojar elemento de fijación		Ajustar
	Befestigungsteil lösen		Einstellen
	Desapertar fixador		Ajustar
	Allentare il fissaggio		Regolare
	Bevestiging losdraaien		Afstellen
Desserrez les fixations	Ajuster		

**TOOLS REQUIRED FOR INSTALLATION**

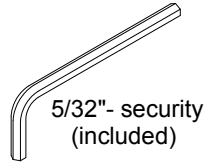

5/32" - security  
(included)

**PARTS**

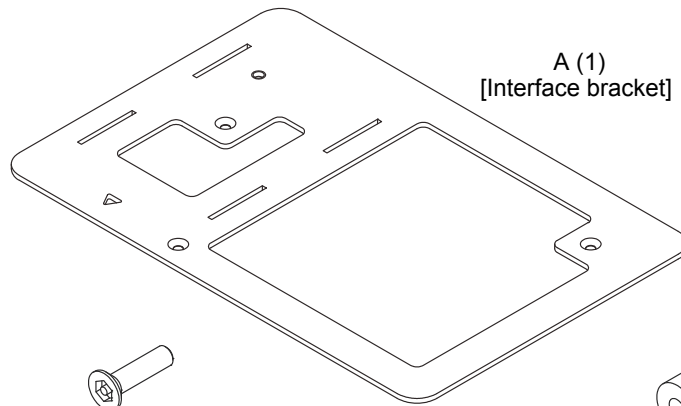

A (1)  
[Interface bracket]

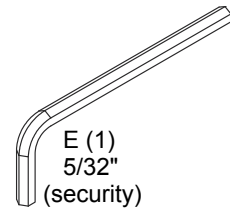

E (1)  
5/32"  
(security)



B (1)  
1/4-20 x 1/2"  
(security)



C (3)  
M4 x 20mm  
(security)



D (3)  
.500 x .194 x .375"

## INSTALLATION



**WARNING: OVER TIGHTENING OF SCREWS CAN DAMAGE PARTS AND MAY LEAD TO SERIOUS PERSONAL INJURY AND DAMAGE TO EQUIPMENT! DO NOT over tighten screws when installing interface bracket.**

**IMPORTANT ! :** Line up the triangle on the interface bracket (A) with the center of the projector lens.

1. Turn projector upside down on a flat surface.
2. Place three spacers (D) over the threaded inserts in the bottom of the projector.
3. Place the interface bracket (A) onto the bottom of the projector, aligning the mounting holes in the bracket with the spacers and threaded inserts in the bottom of the projector, and ensuring that triangle in bracket points towards front of projector, and lines up with center of the projector lens. (See Figure 1)
4. Position M4 x 20mm flat head security screws (C) into the interface bracket (A) mounting holes, through the spacers and into the threaded inserts.
5. Tighten all fasteners at this time, securing the bracket to the projector.

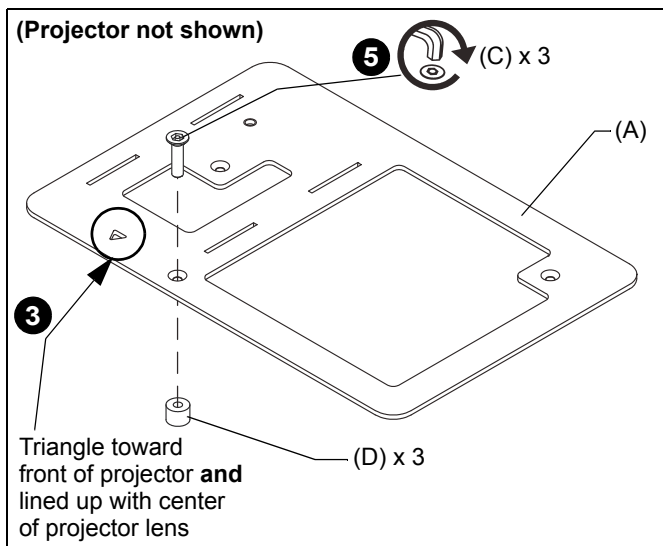

Figure 1

6. Lift interface bracket (A) with projector up to end of the existing SMART Board projector mount arm, and slide interface bracket slots onto hooks. (See Figure 2)

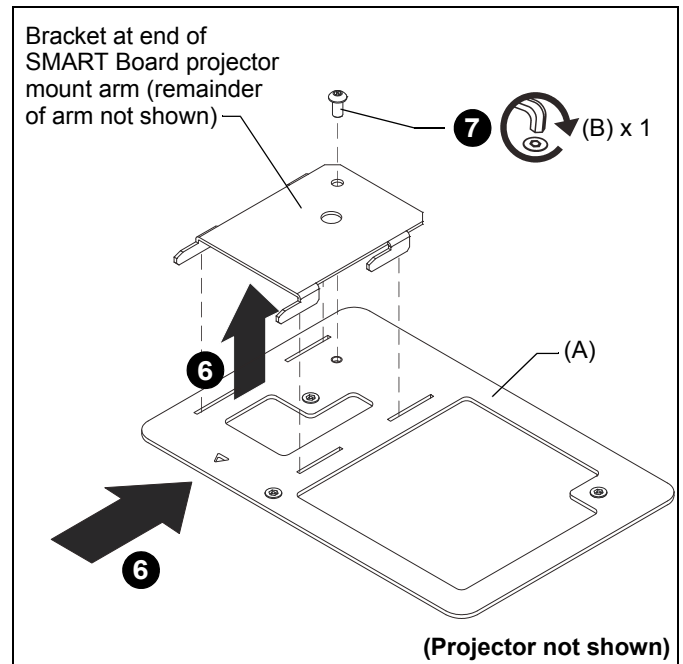

Figure 2

7. Fasten interface bracket (A) to end of SMART Board projector arm using one 1/4-20 x 1/2" button head security screw (B). (See Figure 2)

8. Adjust SMART Board projector arm to correct location according to SMART Board model, and following information in Table 2. (See Figure 3)
9. Fasten SMART Board projector arm in place using hardware provided with SMART Board projector arm system.

**Table 2: SMART Board Projector Arm Adjustment**

Manufacturer	Projector Model	SMART Board Models (i3 and i4 Series)		
		SB660 (4.3)	SB680 SB880 (4.3)	SB685 SB885 (16.10)
InFocus	IN126STa	Holes 4 & 5	Holes 4 & 5	Holes 4 & 5

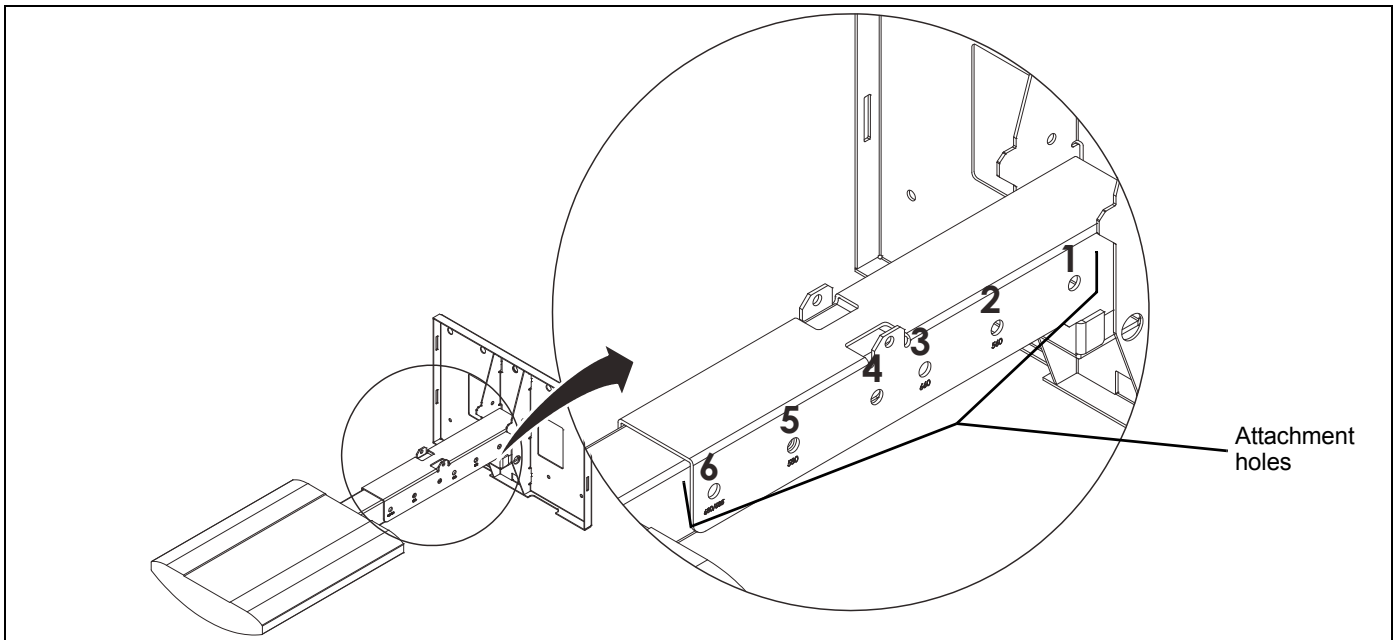

**Figure 3**



**InFocus**

8800-002803 Rev00  
©2015 InFocus Corporation  
[www.infocus.com](http://www.infocus.com)  
11/15

**InFocus Corporation**

**13190 SW 68th Parkway, Ste 200  
Portland, OR 97223**

