

INSTALLATION INSTRUCTIONS

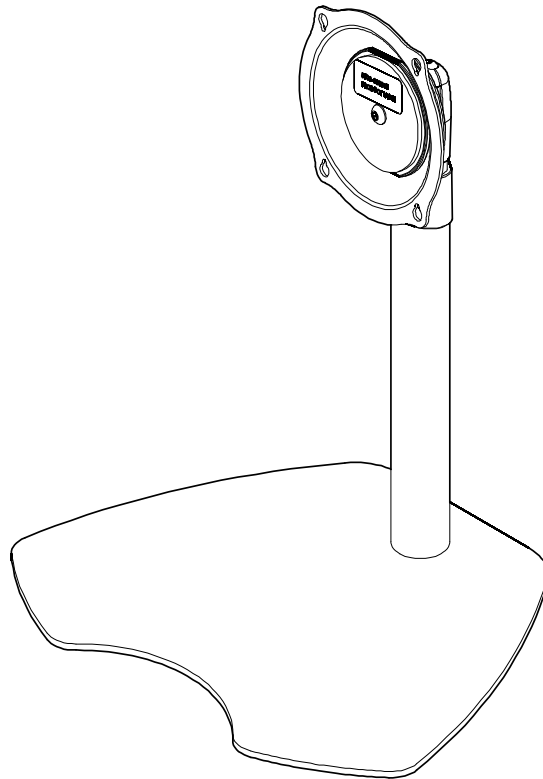

Pole Mount and Stand Accessory

DISCLAIMER

Milestone AV Technologies, Inc., and its affiliated corporations and subsidiaries (collectively, "Milestone"), intend to make this manual accurate and complete. However, Milestone makes no claim that the information contained herein covers all details, conditions or variations, nor does it provide for every possible contingency in connection with the installation or use of this product. The information contained in this document is subject to change without notice or obligation of any kind. Milestone makes no representation of warranty, expressed or implied, regarding the information contained herein. Milestone assumes no responsibility for accuracy, completeness or sufficiency of the information contained in this document.

Chief® and Centris™ are registered trademarks of Milestone AV Technologies. All rights reserved.

IMPORTANT WARNINGS AND CAUTIONS!

 **WARNING:** A WARNING alerts you to the possibility of serious injury or death if you do not follow the instructions.





 **CAUTION:** A CAUTION alerts you to the possibility of damage or destruction of equipment if you do not follow the corresponding instructions.

 **WARNING:** Failure to read, thoroughly understand, and follow all instructions can result in serious personal injury, damage to equipment, or voiding of factory warranty! It is the installer's responsibility to make sure all components are properly assembled and installed using the instructions provided.

 **WARNING:** Failure to provide adequate structural strength for this component can result in serious personal injury or damage to equipment! It is the installer's responsibility to make sure the structure to which this component is attached can support five times the combined weight of all equipment. Reinforce the structure as required before installing the component.

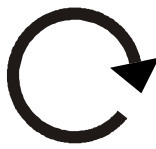
 **WARNING:** Exceeding the weight capacity can result in serious personal injury or damage to equipment! It is the installer's responsibility to make sure the combined weight of all components attached to this accessory does not exceed 35 lbs (15.9 kg). DO NOT exceed the weight limitations of the mount being installed.

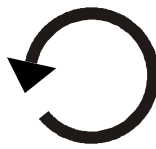
LEGEND

| | | | |
|---|------------------------------|---|---------------------------|
|  | Tighten Fastener |  | By Hand |
| | Apretar elemento de fijación | | A mano |
| | Befestigungsteil festziehen | | Von Hand |
| | Apertar fixador | | Com a mão |
| | Serrare il fissaggio | | A mano |
| | Bevestiging vastdraaien | | Met de hand |
| Serrez les fixations | À la main | | |
|  | Loosen Fastener |  | Hex-Head Wrench |
| | Aflojar elemento de fijación | | Llave de cabeza hexagonal |
| | Befestigungsteil lösen | | Sechskantschlüssel |
| | Desapertar fixador | | Chave de cabeça sextavada |
| | Allentare il fissaggio | | Chiave esagonale |
| | Bevestiging losdraaien | | Zeskantsleutel |
| Desserrez les fixations | Clé à tête hexagonale | | |

TOOLS / PARTS FOR INSTALLATION

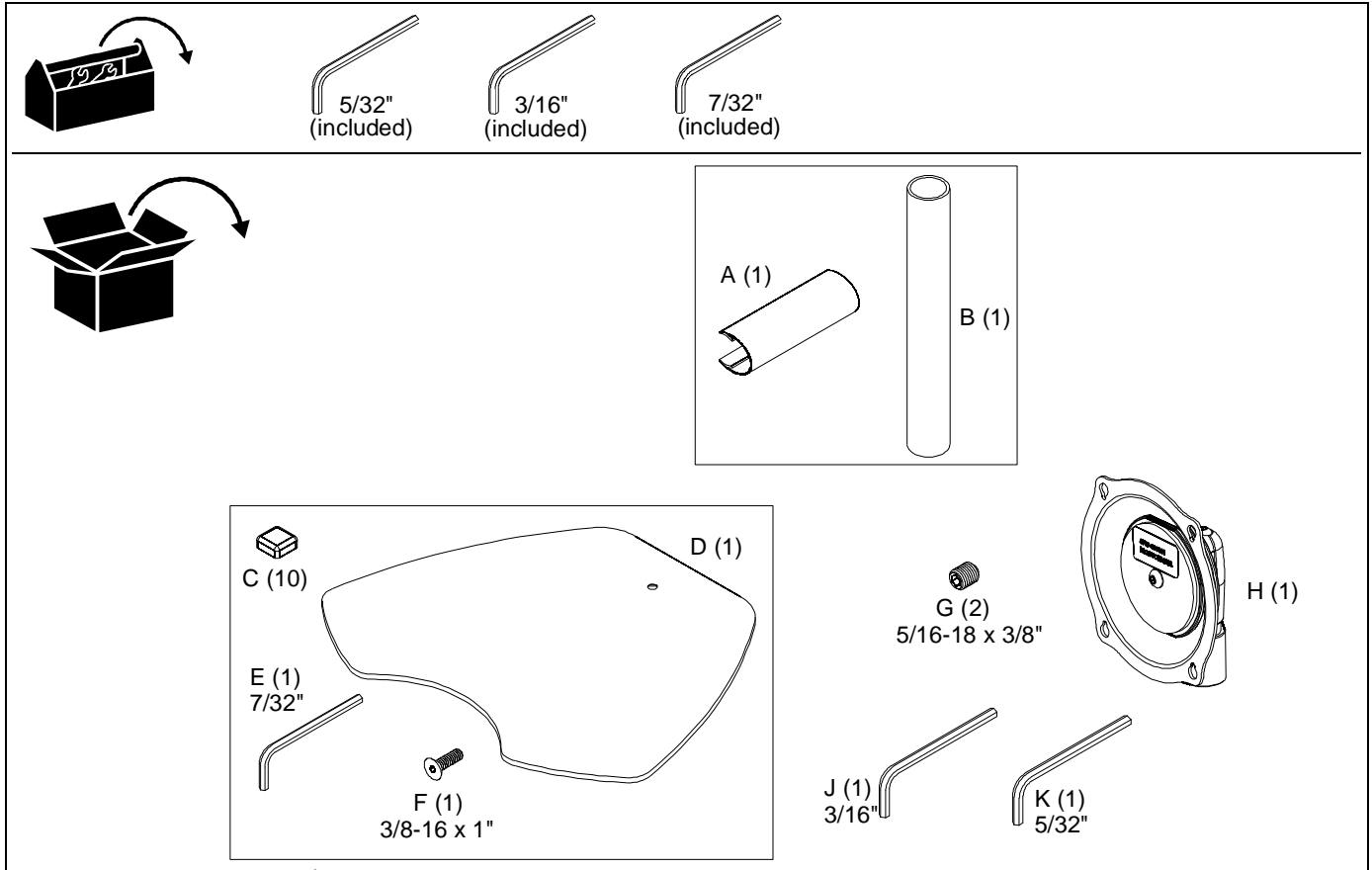

Assembly

1. Attach rubber bumpers (C) to underside of base (D).
2. Attach pole mount (B) to base (D) using one 3/8-16 x 1" flat head screw (F), following instructions included with the base and pole kits.



WARNING: IMPROPER INSTALLATION CAN LEAD TO DISPLAY FALLING CAUSING SERIOUS PERSONAL INJURY OR DAMAGE TO EQUIPMENT! DO NOT substitute hardware! Use only hardware provided by manufacturer.

3. Slide Centris head assembly (H) onto pole mount.
4. Tighten head assembly to pole using two 5/16-18 x 3/8" set screws (G). (See Figure 1)
5. Attach display to head assembly following instructions included with display.

Cable Management

1. Connect cables to display.
2. Route cables from display and down pole, using cable sheath (A) and following instructions included with pole kit.

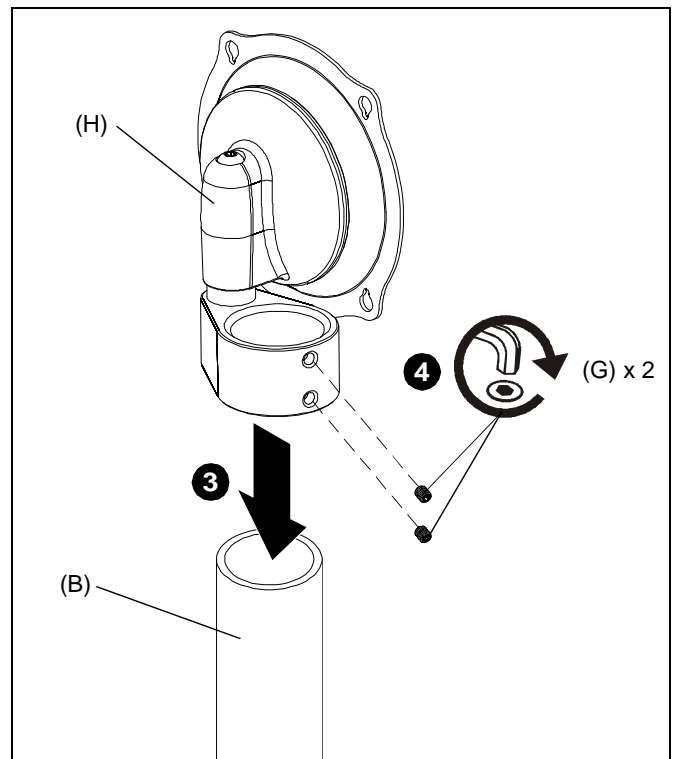

Figure 1



Our Mounts. **Your Vision.**

Chief Manufacturing, a products division
of Milestone AV Technologies

8832-002006 Rev00
©2009 Milestone AV Technologies, a
Duchossois Group Company
www.chiefmfg.com
02/09

| | |
|--------------------------|--|
| USA/International | A 8401 Eagle Creek Parkway, Savage, MN 55378 P 800.582.6480 / 952.894.6280 F 877.894.6918 / 952.894.6918 |
| Europe | A Fellenoord 130 5611 ZB EINDHOVEN, The Netherlands P +31 (0)40 2668620 F +31 (0)40 2668615 |
| Asia Pacific | A Room 24F, Block D, Lily YinDu International Building LuoGang, BuJi Town, Shenzhen, CHINA. 深圳市布吉罗岗村百合银都国际大厦D栋24F P +86-755-8996 9226 F +86-755-8996 9217 |

