

---

# INSTALLATION INSTRUCTIONS

---

---

**Grommet Accessory**

---

---

 **CHIEF**<sup>®</sup>

**MSP-WLKTA1000B**

---

## DISCLAIMER

Milestone AV Technologies, Inc., and its affiliated corporations and subsidiaries, intend to make this manual accurate and complete. However, Milestone makes no claim that the information contained herein covers all details, conditions or variations, nor does it provide for every possible contingency in connection with the installation or use of this product. The information contained in this document is subject to change without notice or obligation of any kind. Milestone makes no representation of warranty, expressed or implied, regarding the information contained herein. Milestone assumes no responsibility for accuracy, completeness or sufficiency of the information contained in this document.

## ⚠ IMPORTANT WARNINGS AND CAUTIONS!

**⚠ WARNING:** A WARNING alerts you to the possibility of serious injury or death if you do not follow the instructions.

**⚠ CAUTION:** A CAUTION alerts you to the possibility of damage or destruction of equipment if you do not follow the corresponding instructions.

**⚠ WARNING:** Failure to read, thoroughly understand, and follow all instructions can result in serious personal injury, damage to equipment, or voiding of factory warranty! It is the installer's responsibility to make sure all components are properly assembled and installed using the instructions provided.

**⚠ WARNING:** Failure to provide adequate structural strength for this component can result in serious personal injury or damage to equipment! It is the installer's responsibility to make sure the structure to which this component is attached can support five times the combined weight of all equipment. Reinforce the structure as required before installing the component.

**⚠ WARNING:** Exceeding the weight capacity can result in serious personal injury or damage to equipment! It is the installer's responsibility to make sure the combined weight of all components located between the MSP-WLKTA1000B up to (and including) the display does not exceed 120 lbs (54.43 kg).

- The weight capacity of the MSP-WLKTA1000B may be LIMITED to the lowest weight capacity of any other component located between the MSP-WLKTA1000B and the supporting structure!

## DIMENSIONS

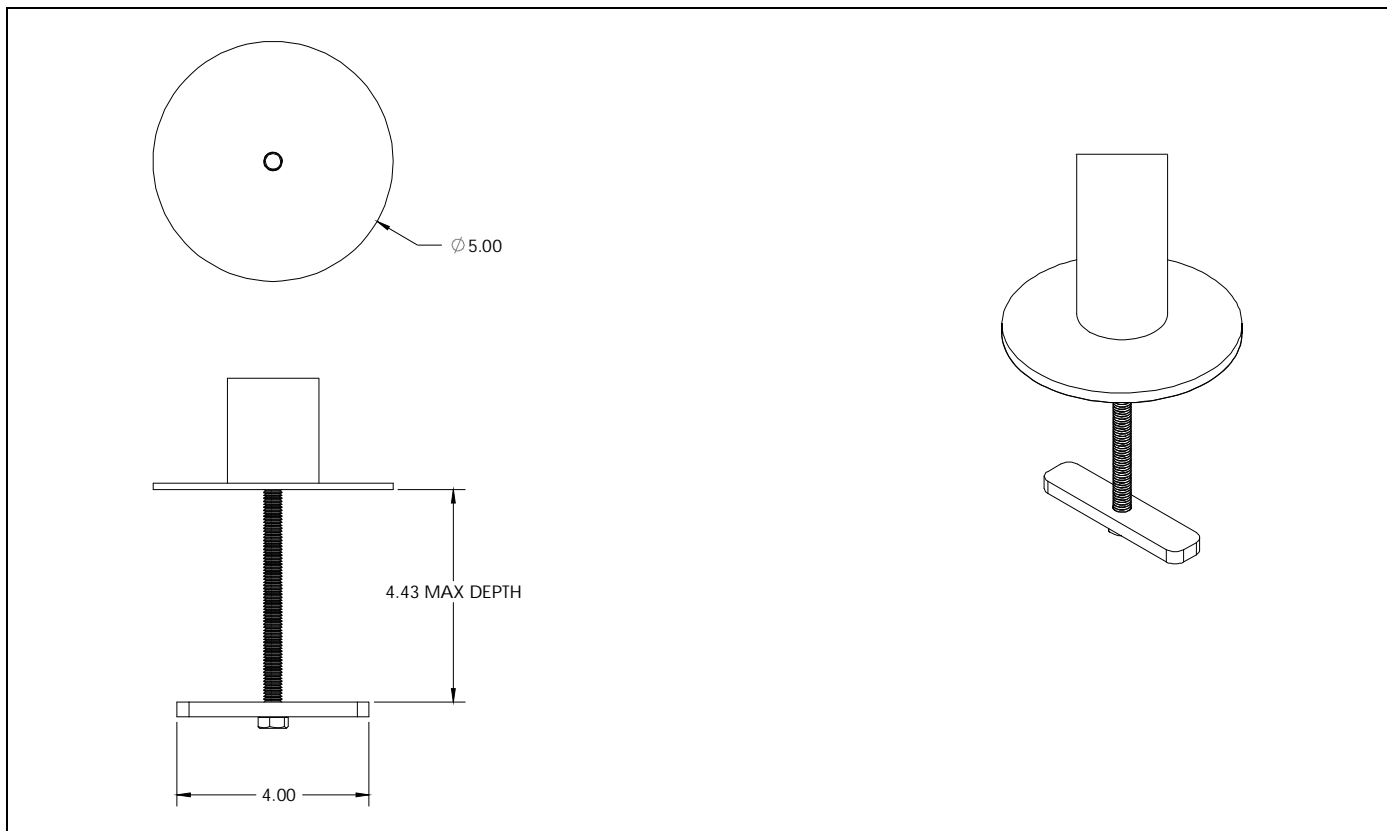

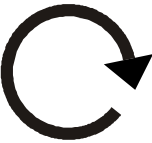

**LEGEND**

	Tighten Fastener
	Apretar elemento de fijación
	Befestigungsteil festziehen
	Apertar fixador
	Serrare il fissaggio
	Bevestiging vastdraaien
Serrez les fixations	

	Pencil Mark
	Marcar con lápiz
	Stiftmarkierung
	Marcar com lápis
	Segno a matita
	Potloodmerkten
Marquage au crayon	

	Loosen Fastener
	Aflojar elemento de fijación
	Befestigungsteil lösen
	Desapertar fixador
	Allentare il fissaggio
	Bevestiging losdraaien
Desserrez les fixations	

	Drill Hole
	Perforar
	Bohrloch
	Fazer furo
	Praticare un foro
	Gat boren
Percez un trou	

	Open-Ended Wrench
	Llave de boca
	Gabelschlüssel
	Chave de bocas
	Chiave a punte aperte
	Steeksleutel
Clé à fourche	

**TOOLS REQUIRED FOR INSTALLATION**

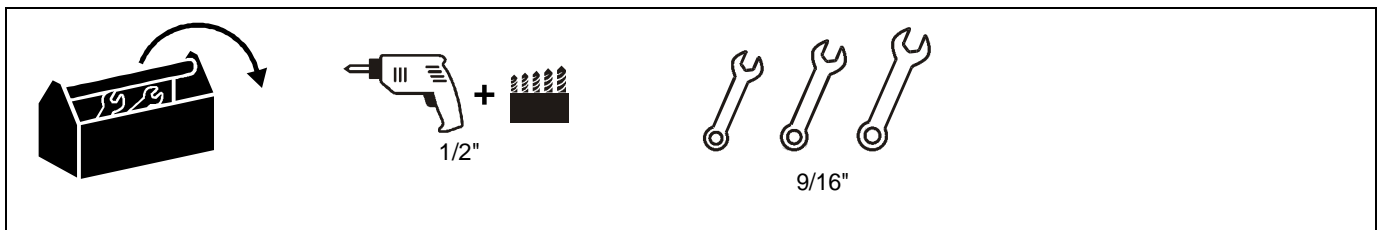

**PARTS**

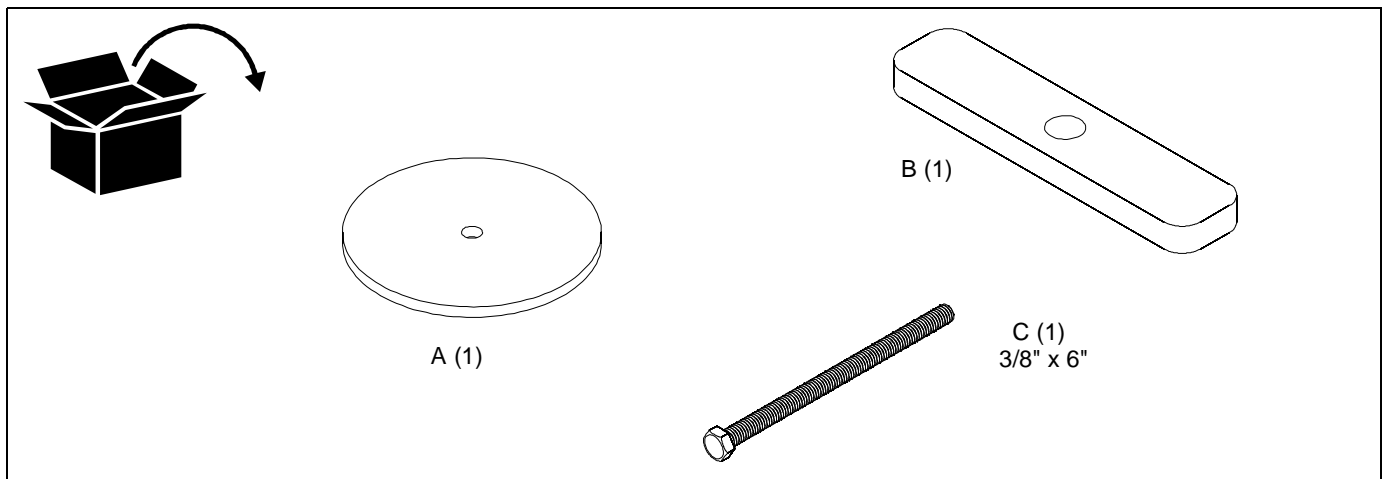

## INSTALLATION

**IMPORTANT !** : If the display being installed has a recessed mounting surface, the display must be assembled to the mount prior to mount installation.



**WARNING:** ELECTRICAL SHOCK HAZARD! Drilling into electrical wires and cables can cause DEATH or SERIOUS PERSONAL INJURY! ALWAYS make certain area under mounting surface is free of electrical wires and cables before drilling.



**WARNING:** EXPLOSION AND FIRE HAZARD! Drilling into gas plumbing can cause DEATH or SERIOUS PERSONAL INJURY! ALWAYS make certain area under mounting surfaces is free of gas, water, waste, or any other plumbing before drilling.

1. Determine approximate location for mount keeping in mind display size, extension, height adjustment (if applicable), and pitch/roll requirements.

**NOTE:** The mounting surface may have a maximum depth of 4.43".

2. Mark installation location and drill one 1/2" dia. pilot hole through mounting surface. (See Figure 1)
3. Position grommet mounting bracket (B) underneath mounting surface and grommet (A) on top of mounting surface and align mounting holes with pilot hole. (See Figure 1)
4. Align mounting hole in bottom of pole with mounting hole in grommet (A) and secure to mounting surface using one 3/8-16 x 6" hex head bolt (C). (See Figure 1)

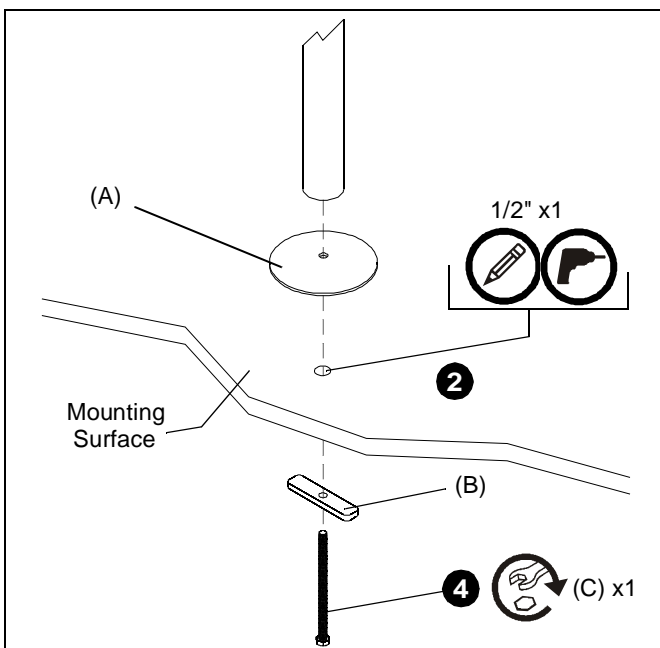

Figure 1



8832-000248  
©2008 Chief Manufacturing  
[www.chiefmfg.com](http://www.chiefmfg.com)  
03/08

<b>USA/International</b>	<b>A</b> 8401 Eagle Creek Parkway, Savage, MN 55378 <b>P</b> 800.582.6480 / 952.894.6280 <b>F</b> 877.894.6918 / 952.894.6918
<b>Europe</b>	<b>A</b> Fellenoord 130 5611 ZB EINDHOVEN, The Netherlands <b>P</b> +31 (0)40 2668620 <b>F</b> +31 (0)40 2668615
<b>Asia Pacific</b>	<b>A</b> Room 24F, Block D, Lily YinDu International Building LuoGang, BuJi Town, Shenzhen, CHINA. <b>深圳市布吉罗岗村百合银都国际大厦D栋24F</b> <b>P</b> +86-755-8996 9226 <b>F</b> +86-755-8996 9217