

INSTALLATION INSTRUCTIONS

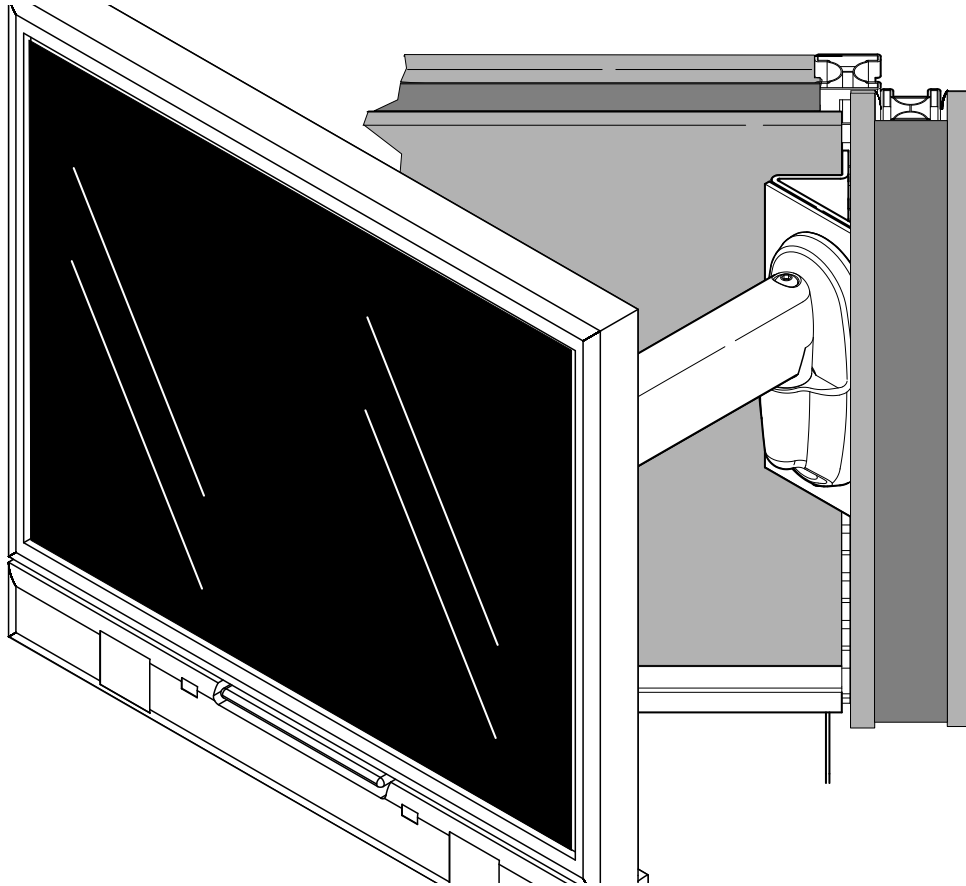

Office Furniture Wall Bracket

DISCLAIMER

CSAV, Inc., and its affiliated corporations and subsidiaries (collectively, "CSAV"), intend to make this manual accurate and complete. However, CSAV makes no claim that the information contained herein covers all details, conditions or variations, nor does it provide for every possible contingency in connection with the installation or use of this product. The information contained in this document is subject to change without notice or obligation of any kind. CSAV makes no representation of warranty, expressed or implied, regarding the information contained herein. CSAV assumes no responsibility for accuracy, completeness or sufficiency of the information contained in this document.



IMPORTANT WARNINGS AND CAUTIONS!



WARNING: A WARNING alerts you to the possibility of serious injury or death if you do not follow the instructions.



CAUTION: A CAUTION alerts you to the possibility of damage or destruction of equipment if you do not follow the corresponding instructions.



WARNING: Failure to read, thoroughly understand, and follow all instructions can result in serious personal injury, damage to equipment, or voiding of factory warranty! It is the installer's responsibility to make sure all components are properly assembled and installed using the instructions provided.





WARNING: Failure to provide adequate structural strength for this component can result in serious personal injury or damage to equipment! It is the installer's responsibility to make sure the structure to which this component is attached can support five times the combined weight of all equipment. Reinforce the structure as required before installing the component.



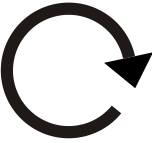

WARNING: Exceeding the weight capacity can result in serious personal injury or damage to equipment! It is the installer's responsibility to make sure the combined weight of all components attached to this accessory does not exceed 40 lbs (18 kg).

LEGEND



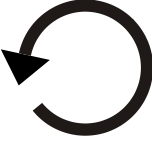

	Tighten Fastener
	Apretar elemento de fijación
	Befestigungsteil festziehen
	Apertar fixador
	Serrare il fissaggio
	Bevestiging vastdraaien
Serrez les fixations	

	By Hand
	A mano
	Von Hand
	Com a mão
	A mano
	Met de hand
À la main	

	Loosen Fastener
	Aflojar elemento de fijación
	Befestigungsteil lösen
	Desapertar fixador
	Allentare il fissaggio
	Bevestiging losdraaien
Desserrez les fixations	

	Phillips Screwdriver
	Destornillador Phillips
	Kreuzschlitzschraubendreher
	Chave de fendas Phillips
	Cacciavite a stella
	Kruiskopschroevendraaier
Tournevis à pointe cruciforme	

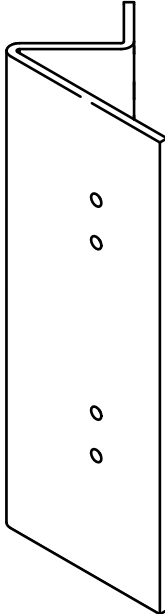
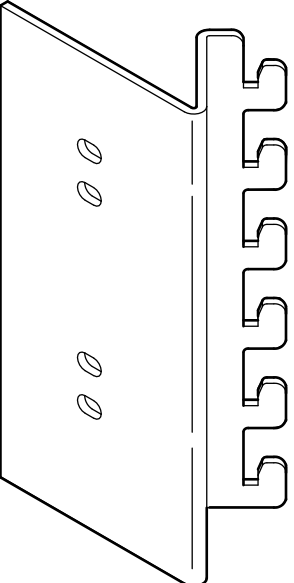
TOOLS REQUIRED FOR INSTALLATION AND PARTS

	
	<div style="display: flex; justify-content: space-around; align-items: center;"> <div style="text-align: center;"> <p>A(1)</p>  </div> <div style="text-align: center;"> <p>B(1)</p>  </div> </div> <div style="margin-top: 20px;"> <p>C (4) 10-24 x 3/8"</p>  </div>

Assembly And Installation

1. Identify desired mounting location considering display size and mount capabilities when determining location.
2. Orient *Tapped* wall bracket (Tabs facing DOWN) as shown in figure 1 below, and install six tabs on *Tapped* wall bracket into six slots in wall support.

⚠ WARNING: IMPROPER INSTALLATION CAN LEAD TO DISPLAY FALLING CAUSING SERIOUS PERSONAL INJURY OR DAMAGE TO EQUIPMENT!! Make certain wall bracket tabs are properly seated in slots in wall support.

3. Orient *Slotted* wall bracket (Tabs facing UP) as shown in figure 1 below, and install six tabs on *Slotted* wall bracket into six slots in wall support.

IMPORTANT ! : When properly installed the flat face of the Slotted bracket will be on the outside. (See Figure 2)

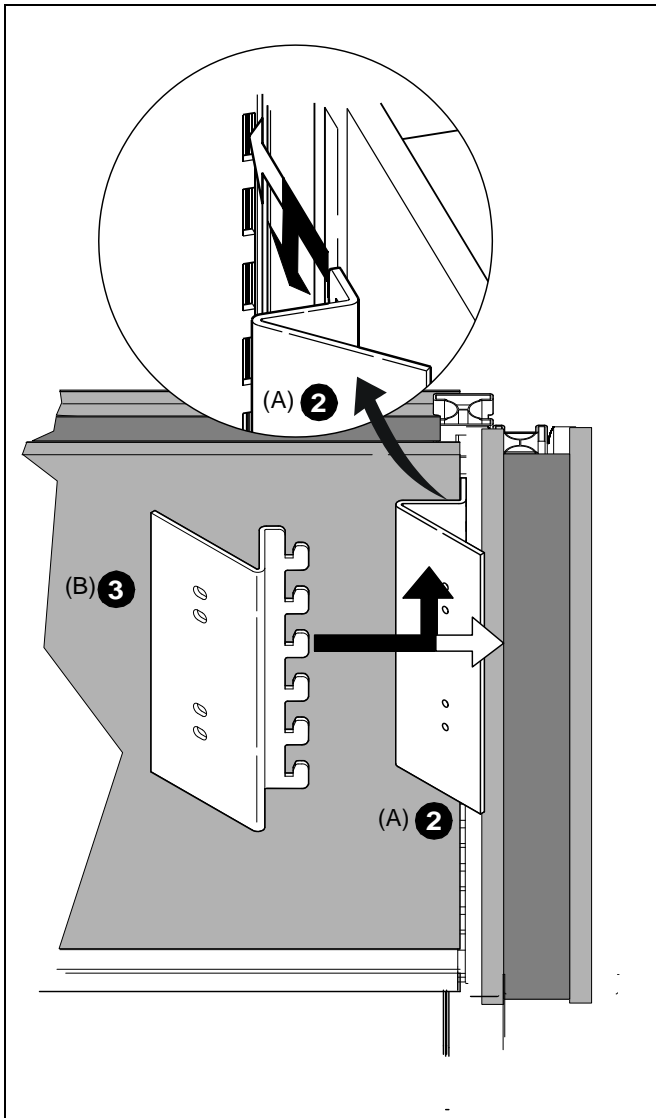

Figure 1

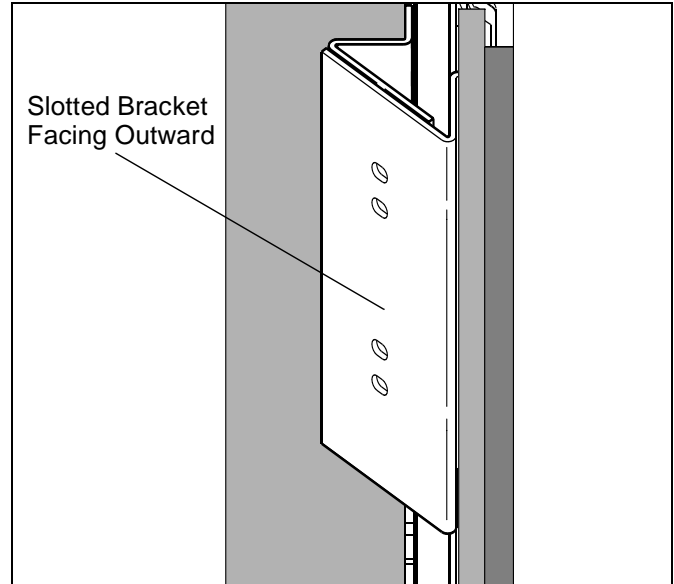

Figure 2

4. Secure mount wall bracket (included with mount) to *Tapped* and *Slotted* wall brackets using a Phillips screw driver and four 10-24 x 3/8" Phillips pan head screws.

⚠ WARNING: IMPROPER INSTALLATION CAN LEAD TO DISPLAY FALLING CAUSING SERIOUS PERSONAL INJURY OR DAMAGE TO EQUIPMENT! DO NOT substitute hardware! Use only hardware provided by manufacturer.

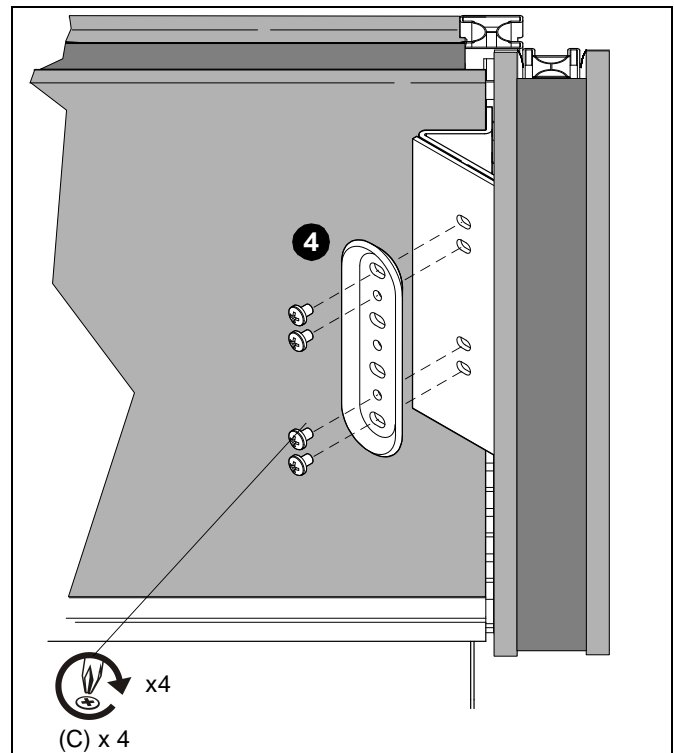

Figure 3

5. Continue with mount installation, following the instructions provided with the mount.



8812-000035
©2006 Chief Manufacturing
www.chiefmfg.com
07/06

USA/International	A 8401 Eagle Creek Parkway, Savage, MN 55378 P 800.582.6480 / 952.894.6280 F 877.894.6918 / 952.894.6918
Europe	A Fellenoord 130 5611 ZB EINDHOVEN, The Netherlands P +31 40 2668620 F +31 (0) 40 2668615
Asia Pacific	A Room 30I, Block D, Lily YinDu International Building LuoGang, BuJi Town, Shenzhen, CHINA. Post Code: 518112 深圳市布吉罗岗百合银都国际大厦D栋30I P +86-755-8996 9226 ; 8996 9236 ; 8996 9220 F +86-755-8996 9217