

INSTALLATION INSTRUCTIONS

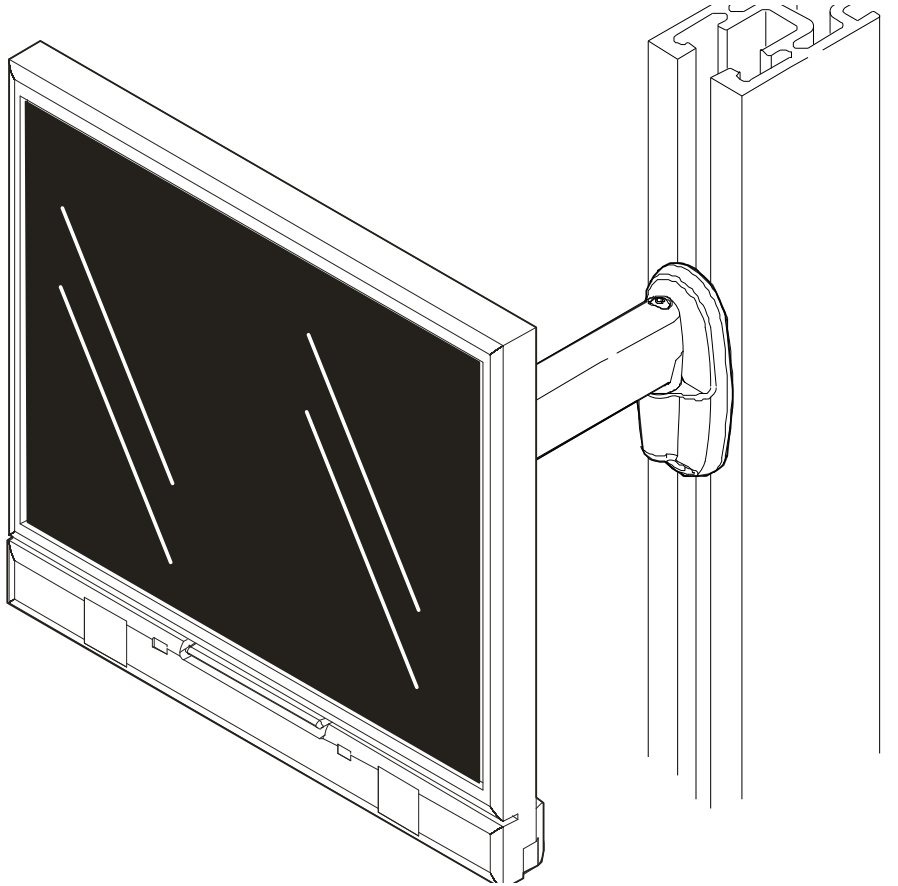

Office Furniture Wall Bracket

DISCLAIMER

CSAV, Inc., and its affiliated corporations and subsidiaries (collectively, "CSAV"), intend to make this manual accurate and complete. However, CSAV makes no claim that the information contained herein covers all details, conditions or variations, nor does it provide for every possible contingency in connection with the installation or use of this product. The information contained in this document is subject to change without notice or obligation of any kind. CSAV makes no representation of warranty, expressed or implied, regarding the information contained herein. CSAV assumes no responsibility for accuracy, completeness or sufficiency of the information contained in this document.



IMPORTANT WARNINGS AND CAUTIONS!



WARNING: A WARNING alerts you to the possibility of serious injury or death if you do not follow the instructions.



CAUTION: A CAUTION alerts you to the possibility of damage or destruction of equipment if you do not follow the corresponding instructions.



WARNING: Failure to read, thoroughly understand, and follow all instructions can result in serious personal injury, damage to equipment, or voiding of factory warranty! It is the installer's responsibility to make sure all components are properly assembled and installed using the instructions provided.



WARNING: Failure to provide adequate structural strength for this component can result in serious personal injury or damage to equipment! It is the installer's responsibility to make sure the structure to which this component is attached can support five times the combined weight of all equipment. Reinforce the structure as required before installing the component.



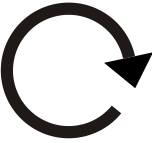

WARNING: Exceeding the weight capacity can result in serious personal injury or damage to equipment! It is the installer's responsibility to make sure the combined weight of all components attached to this accessory does not exceed 40 lbs (18.15 kg).

LEGEND

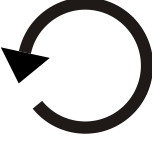

	Tighten Fastener
	Apretar elemento de fijación
	Befestigungsteil festziehen
	Apertar fixador
	Serrare il fissaggio
	Bevestiging vastdraaien
Serrez les fixations	

	By Hand
	A mano
	Von Hand
	Com a mão
	A mano
	Met de hand
À la main	

	Loosen Fastener
	Aflojar elemento de fijación
	Befestigungsteil lösen
	Desapertar fixador
	Allentare il fissaggio
	Bevestiging losdraaien
Desserrez les fixations	

	Phillips Screwdriver
	Destornillador Phillips
	Kreuzschlitzschraubendreher
	Chave de fendas Phillips
	Cacciavite a stella
	Kruiskopschroevendraaier
Tournevis à pointe cruciforme	

TOOLS REQUIRED FOR INSTALLATION AND PARTS

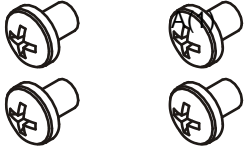
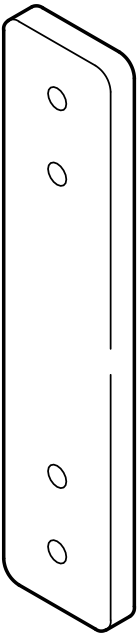
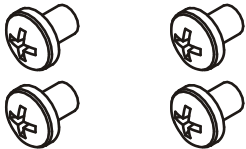
	
	<p>A (4) 10-24 x 5/8"</p>  <p>B(1)</p>  <p>C (4) 10-24 x 1/2"</p> 

Installation

1. Partially install mounting plate (included with mount) to wall plate (B) using four screws (A or C). (See Figure 1)

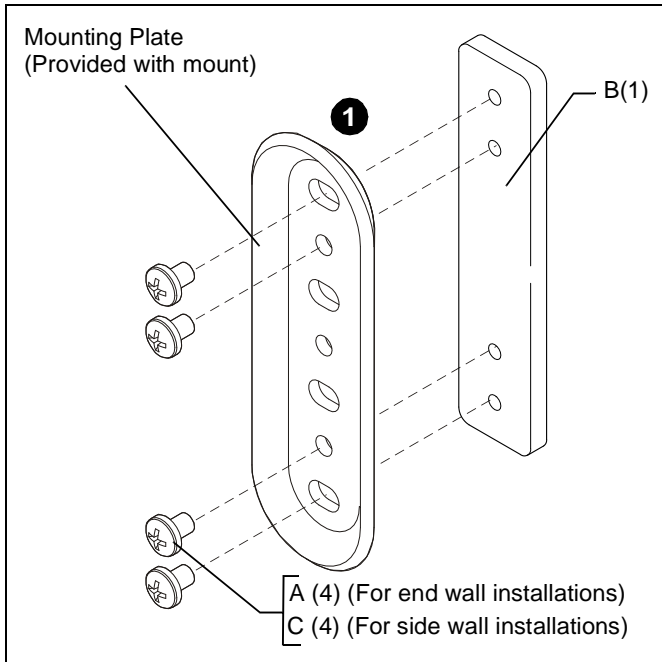

Figure 1

2. Orient mounting plate with wall plate (B) over mounting slot in wall and slide into wall making certain wall is between plates. (See Figure 2)

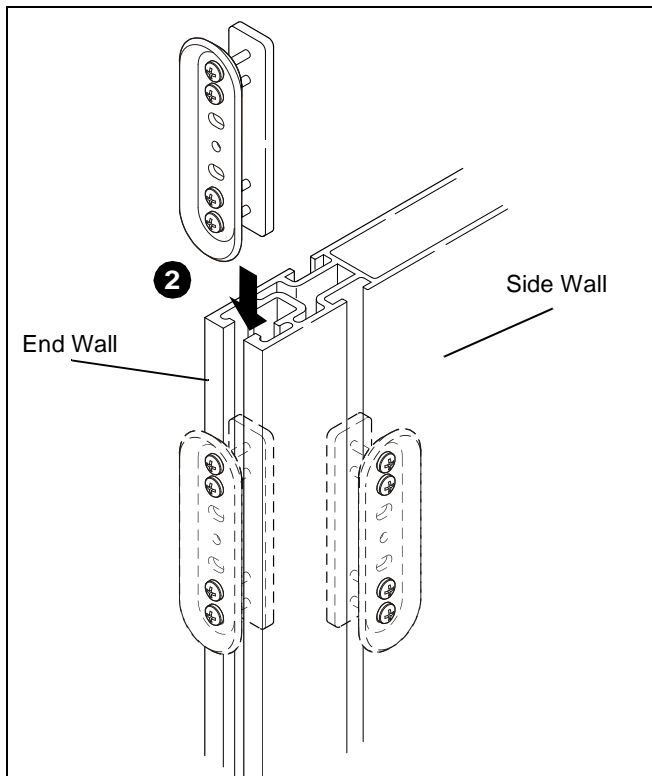

Figure 2

3. Position so that mounting plate is located in desired display mounting location. (See Figure 2)

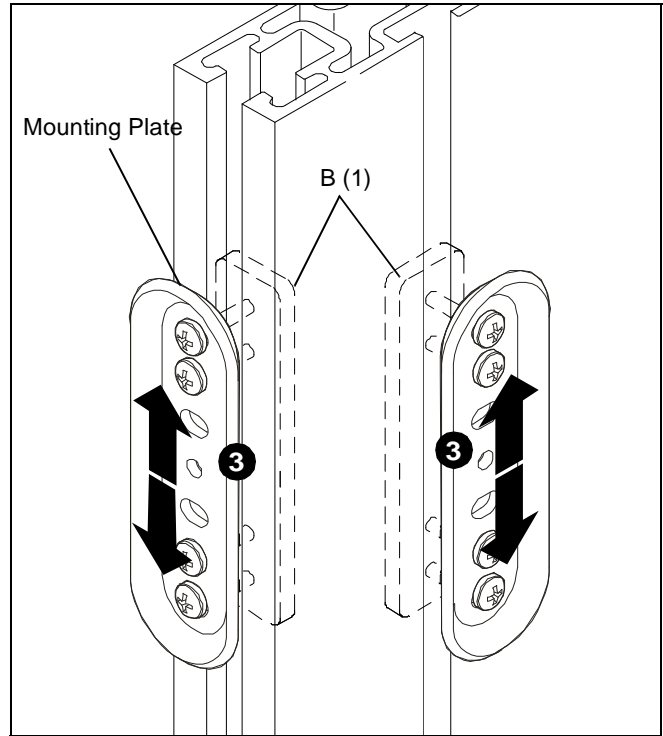

Figure 3

4. Secure wall plate to wall by tightening four screws (A or C). (See Figure 2)

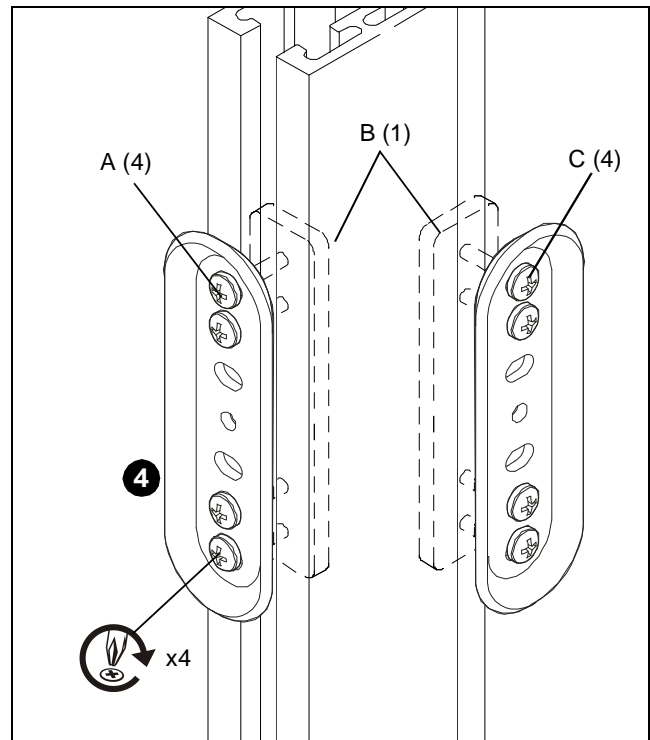

Figure 4

5. Continue with mount installation, following the instructions provided with the mount.



8812-000038
©2007 Chief Manufacturing
www.chiefmfg.com
03/07

USA/International	A 8401 Eagle Creek Parkway, Savage, MN 55378 P 800.582.6480 / 952.894.6280 F 877.894.6918 / 952.894.6918
Europe	A Fellenoord 130 5611 ZB EINDHOVEN, The Netherlands P +31 40 2668620 F +31 (0) 40 2668615
Asia Pacific	A Room 30I, Block D, Lily YinDu International Building LuoGang, BuJi Town, Shenzhen, CHINA. Post Code: 518112 深圳市布吉罗岗百合银都国际大厦D栋30I P +86-755-8996 9226 ; 8996 9236 ; 8996 9220 F +86-755-8996 9217