INSTALLATION INSTRUCTIONS

CPU/DVD and VCR Mounting Accessory

Model: PAC-251

The PAC-251 allows the integration of a CPU, DVD Player or VCR into installations using most Chief Large Flat Panel Display mounts. This accessory easily adapts to Chief's patented Q-Latch™ Mounting system and also allows for easy access to drives and input/output connections.

Fits Equipment Dimensions:

5.125"–17.625" W x 1.5"–3.5" H x 3.5"–15.5" D

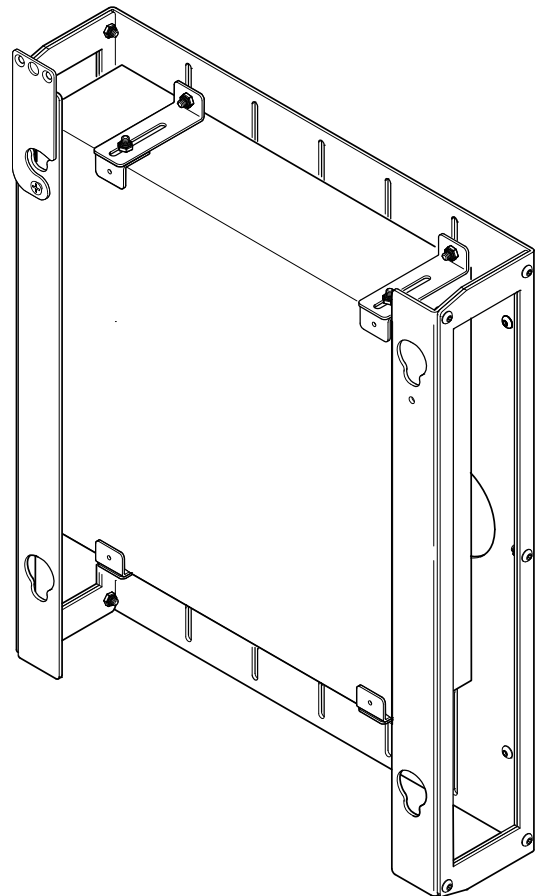

BEFORE YOU BEGIN



WARNING: FAILURE TO READ, THOROUGHLY UNDERSTAND, AND FOLLOW ALL INSTRUCTIONS CAN LEAD TO SERIOUS PERSONAL INJURY, DAMAGE TO EQUIPMENT, OR VOIDING OF FACTORY WARRANTY! It is the installer's responsibility to make sure all components are properly assembled and installed using the instructions provided.

- If you have any questions about these instructions or your specific installation, contact Chief Manufacturing at 1-800-582-6480 or 952-894-6280.

Chief® is a trademark of Milestone AV Technologies, Inc. All rights reserved.



©2008 Chief Manufacturing, a division of Milestone AV Technologies

8401 Eagle Creek Parkway, Savage, MN 55378

P: 800.582.6480 / 952.894.6280 F: 877.894.6918 / 952.894.6918

8809-000011 Rev D

©2008 Milestone AV Technologies

www.chiefmfg.com

10/08



IMPORTANT WARNINGS AND CAUTIONS!

WARNING: A WARNING alerts you to the possibility of serious injury or death if you do not follow the instructions.

CAUTION: A CAUTION alerts you to the possibility of damage or destruction of equipment if you do not follow the corresponding instructions.



WARNING: FAILURE TO PROVIDE ADEQUATE STRUCTURAL STRENGTH FOR THIS ACCESSORY CAN RESULT IN SERIOUS PERSONAL INJURY OR DAMAGE TO EQUIPMENT! It is the installer's responsibility to make sure the structure to which this accessory is attached can support five times the combined weight of all equipment.



WARNING: EXCEEDING MAXIMUM WEIGHT CAPACITY CAN RESULT IN SERIOUS PERSONAL INJURY OR DAMAGE TO EQUIPMENT! It is the installer's responsibility to make sure the combined weight of the PAC-251, device, and any other attached equipment does not exceed the capacity of PST display mount as stated in the installation instructions provided with the PST mount. .

TOOLS REQUIRED FOR INSTALLATION

- 1/8" Hex Wrench (provided)

PARTS

Unpack carton, inspect and verify contents. Read installation instructions completely. If any listed parts are missing, immediately contact a Chief Customer Service representative by calling 1-800-582-6480, or by visiting www.chiefmfg.com.

Item	Description	Qty
10	RACK, device Mounting	1
20	BRACKET, device Holding	4
30	BRACKET, device Mounting	4
40	BUTTON, Mounting	4
50	SCREW, Flat Head Cap, 10-24 x 1/2" (Black)	4
60	SCREW, Round Head Carriage Bolt, 10-24 x 5/8"	4
70	NUT, Nylock, 10-24	8
80	WRENCH, Hex, 1/8" (Provided)	1
90	FLAG, Latching	1
100	SCREW, Phillips Machine, 10-24 x 1/2"	1
110	WASHER, Flat	1

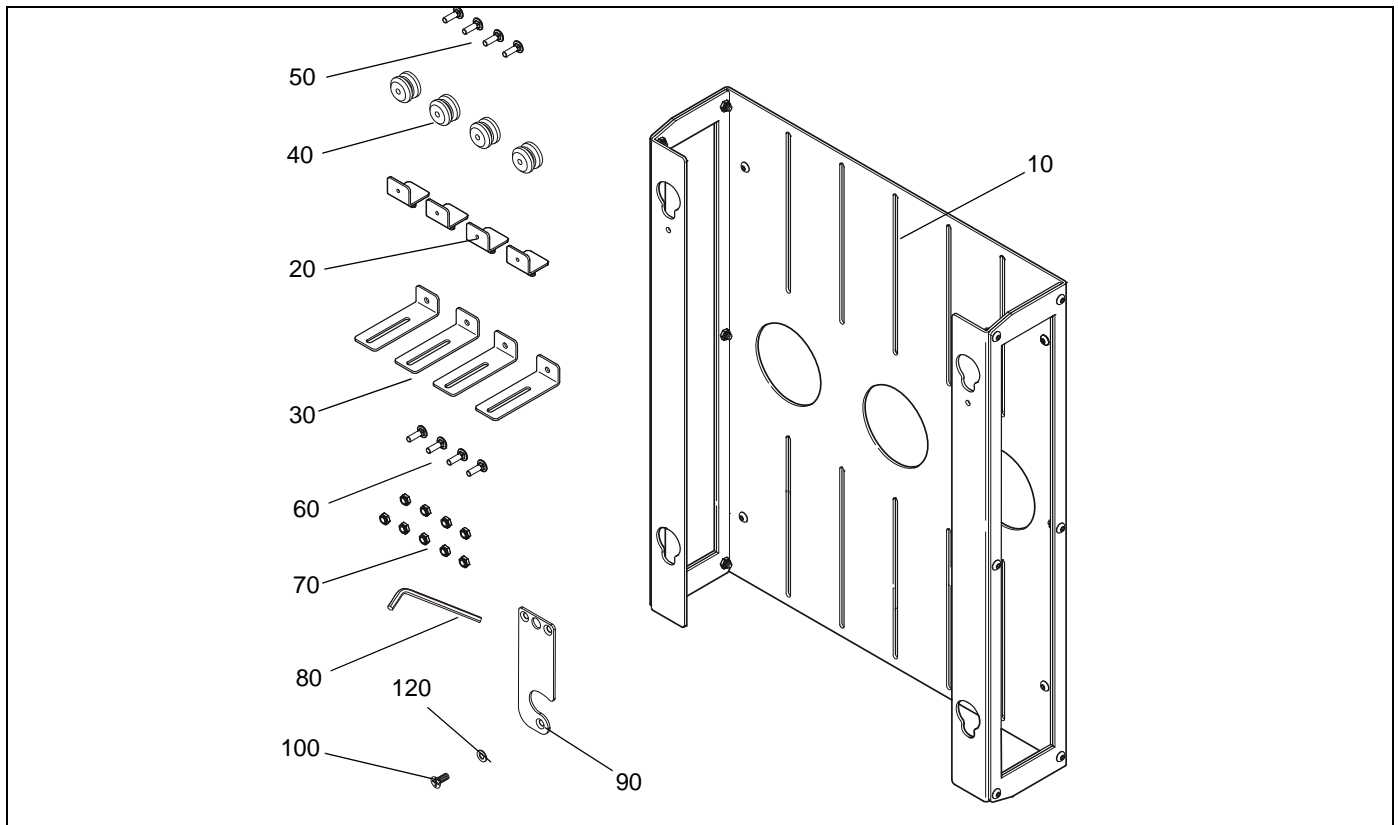
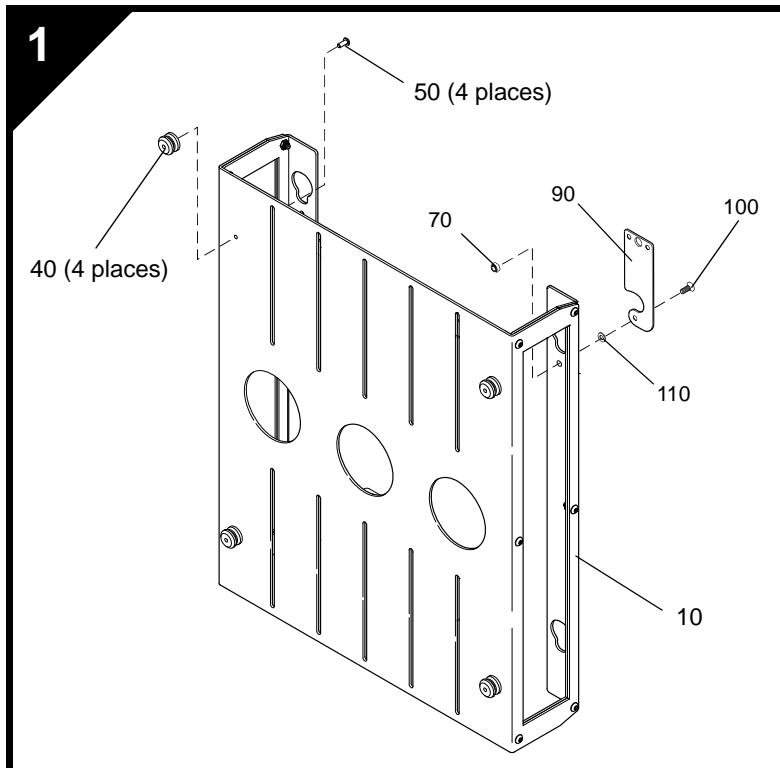

Figure 1: PARTS

INSTALLATION



Install Mounting Buttons and Latching Flag



WARNING: IMPROPER INSTALLATION CAN LEAD TO DEVICE RACK FALLING! Mounting buttons must be securely fastened to device rack.

1. Install four mounting buttons (40) to device rack (10) using four 10-24 x 1/2" flat head cap screws(50).
2. Secure latching flag (90) to CPU holder (10) using one #10-24 x 1/2" Phillips Machine screw (100), one flat washer (110), and one #10-24 lock nut (70).

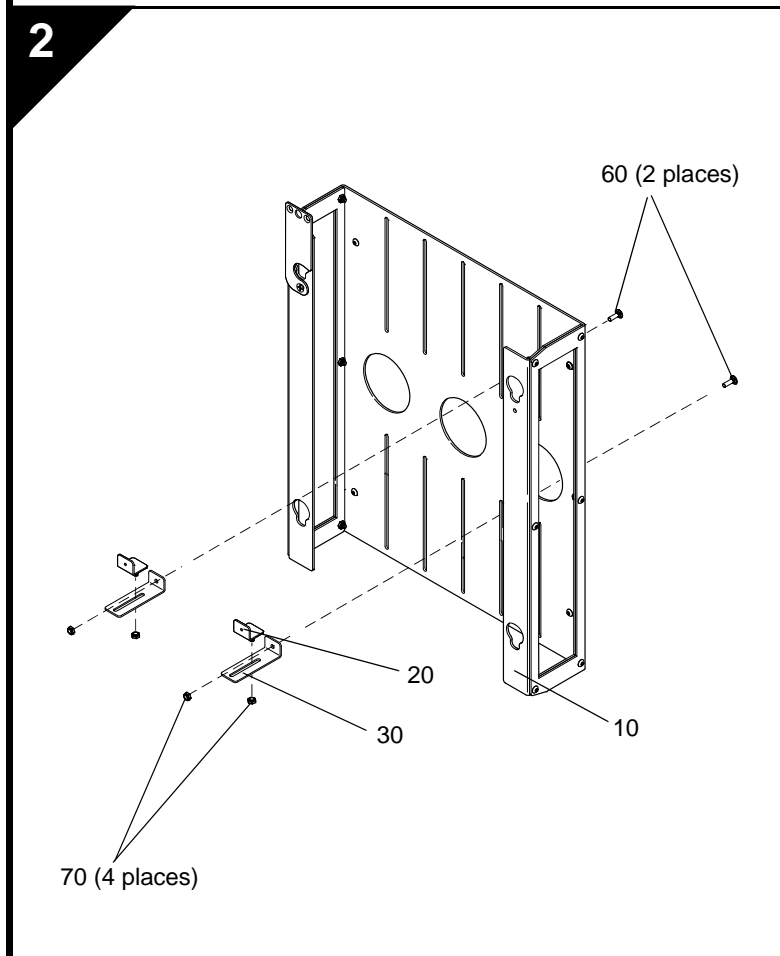

Install Lower device Mounting Brackets



WARNING: IMPROPER INSTALLATION CAN LEAD TO DEVICE FALLING! All mounting brackets must be securely fastened to device rack.

1. Install two lower device mounting brackets (30) to device rack (10) using two 10-24 x 5/8" round head carriage bolts (60) and two 10-24 Nylock nuts (70).

NOTE: Make certain the device mounting brackets (30) are oriented as show in the figure at left. DO NOT tighten hardware at this time!

2. Secure two lower device holding brackets (20) to device mounting brackets (30) using two 10-24 Nylock nuts (70).

NOTE: DO NOT tighten hardware at this time!

3. Measure height of device and position brackets (20 and 30) so that device will be centered vertically in device rack (10).
4. Secure two lower device mounting brackets (30) to device rack (10) by tightening two 10-24 x 5/8" round head carriage bolt (60) and two 10-24 Nylock nuts (70).

3

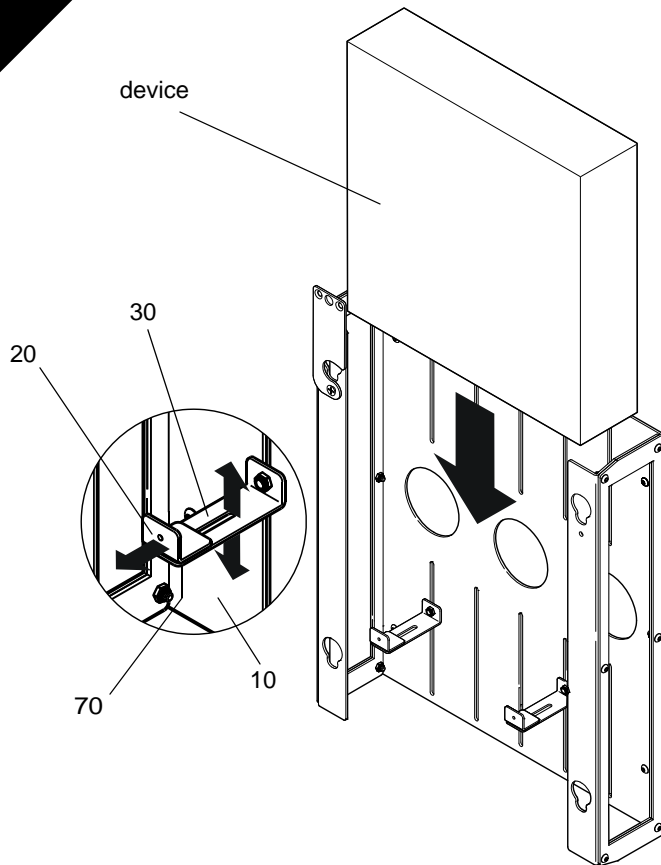

Adjust Lower device Mounting Brackets

1. Position two device holding brackets (20) so that they are at their outermost position. (see detail in figure at left)
2. Slide device into rack until resting on two lower device mounting brackets (30).
3. Slide two device holding brackets (20) forward until they contact device.
4. Tighten two 1/4-20 Nylock nuts (70)

4

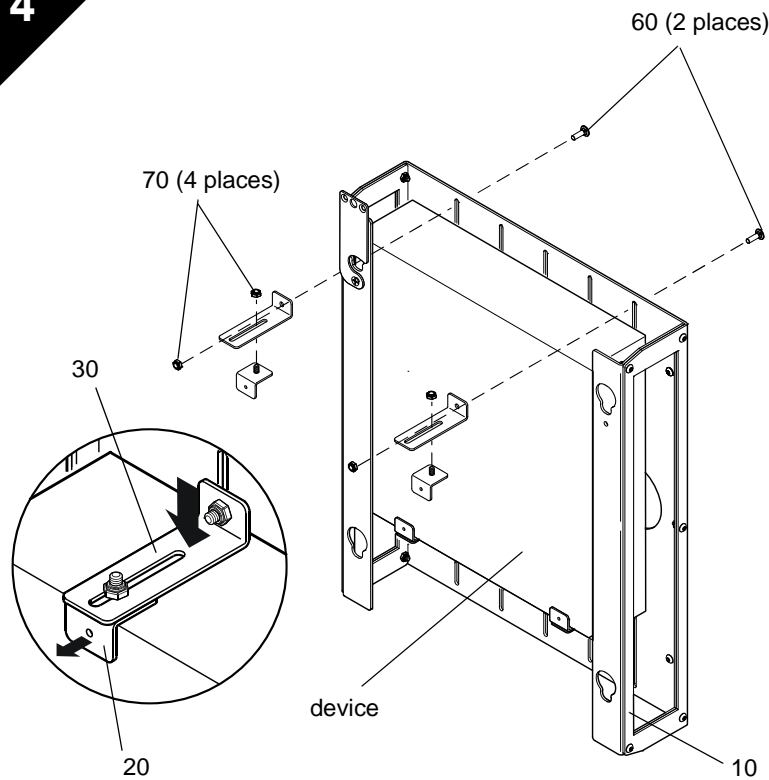

Install Upper Device Mounting Brackets



WARNING: IMPROPER INSTALLATION CAN LEAD TO DEVICE FALLING! All mounting brackets must be securely fastened to device rack.

IMPORTANT ! : Make certain device holding brackets (20) are oriented as shown in figure at left.

1. Install two upper device holding brackets (20) into slots in upper device mounting brackets (30) using two 10-24 Nylock nuts (70).
- NOTE:** DO NOT tighten hardware at this time.
2. Position two upper device holding brackets (20) so that they are at their outermost position. (see detail in figure at left)
3. Secure two upper bottom device mounting brackets (30) to device rack (10) using two 10-24 x 5/8" round head carriage bolts(60) and two 10-24 Nylock nuts (70).

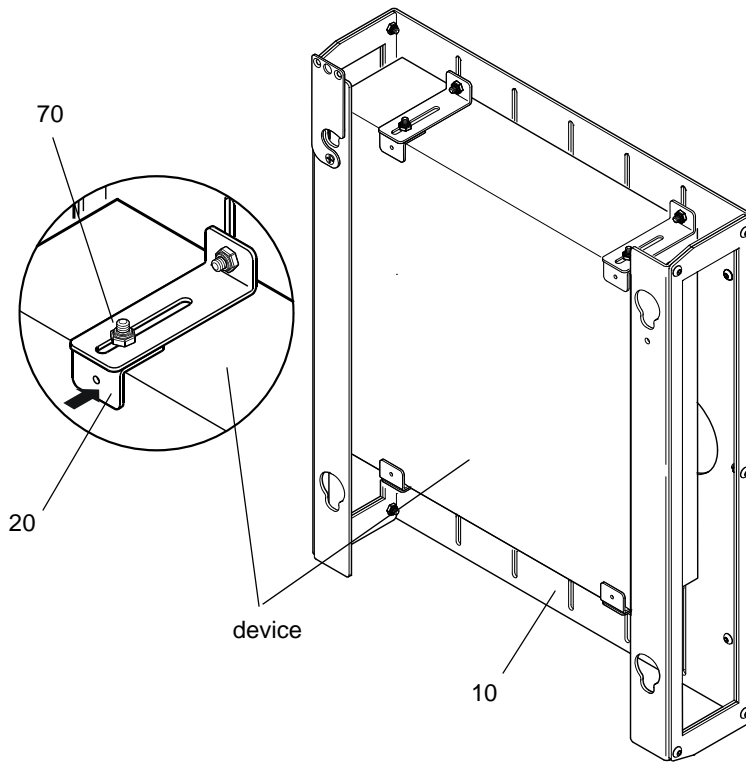
5**Adjust Upper Device Mounting Brackets**

1. Slide two device holding brackets (20) forward until they contact device. (see detail in figure at left)
2. Tighten two 1/4-20 Nylock nuts (70)

6**Install Device Accessory with Device to Mount**

WARNING: COMBINED WEIGHT OF device AND RACK MAY WEIGHT IN EXCESS OF 40 LBS. ALWAYS use two people when lifting and follow proper lifting technicques when installing!

1. Secure device rack with device to PST following the instructions outlined in the manual provided for the PST mount.