

INSTALLATION INSTRUCTIONS

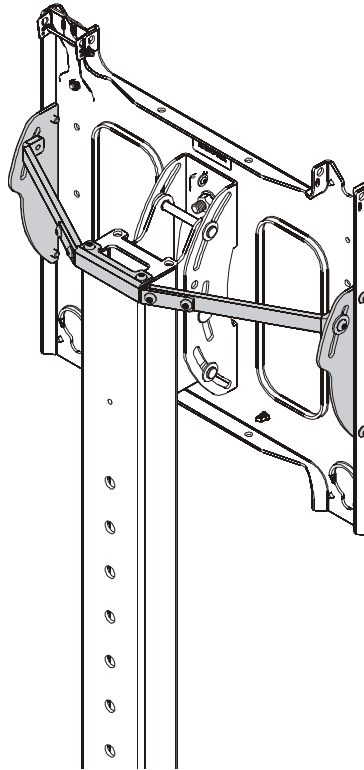

PFC Cart Series Stabilizer Accessory

DISCLAIMER

Milestone AV Technologies and its affiliated corporations and subsidiaries (collectively "Milestone"), intend to make this manual accurate and complete. However, Milestone makes no claim that the information contained herein covers all details, conditions or variations, nor does it provide for every possible contingency in connection with the installation or use of this product. The information contained in this document is subject to change without notice or obligation of any kind. Milestone makes no representation of warranty, expressed or implied, regarding the information contained herein. Milestone assumes no responsibility for accuracy, completeness or sufficiency of the information contained in this document.

Chief® is a registered trademark of Milestone AV Technologies. All rights reserved.



WARNING: Failure to read, thoroughly understand, and follow all instructions can result in serious personal injury, damage to equipment, or voiding of factory warranty! It is the installer's responsibility to make sure all components are properly assembled and installed using the instructions provided.



IMPORTANT WARNINGS AND CAUTIONS!











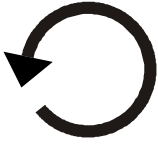

WARNING: A WARNING alerts you to the possibility of serious injury or death if you do not follow the instructions.

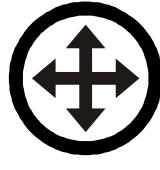

CAUTION: A CAUTION alerts you to the possibility of damage or destruction of equipment if you do not follow the corresponding instructions.

LEGEND

	<p>Tighten Fastener Apretar elemento de fijación Befestigungsteil festziehen Apertar fixador Serrare il fissaggio Bevestiging vastdraaien Serrez les fixations</p>		<p>Pencil Mark Marcar con lápiz Stiftmarkierung Marcar com lápis Segno a matita Potloodmerkteken Marquage au crayon</p>
	<p>Loosen Fastener Aflojar elemento de fijación Befestigungsteil lösen Desapertar fixador Allentare il fissaggio Bevestiging losdraaien Desserrez les fixations</p>		<p>Drill Hole Perforar Bohrloch Fazer furo Praticare un foro Gat boren Percez un trou</p>
	<p>Phillips Screwdriver Destornillador Phillips Kreuzschlitzschraubendreher Chave de fendas Phillips Cacciavite a stella Kruiskopschroevendraaier Tournevis à pointe cruciforme</p>		<p>Adjust Ajustar Einstellen Ajustar Regolare Afstellen Ajuster</p>
	<p>Open-Ended Wrench Llave de boca Gabelschlüssel Chave de bocas Chiave a punte aperte Steeksleutel Clé à fourche</p>		<p>Remove Quitar Entfernen Remover Rimuovere Verwijderen Retirez</p>
	<p>By Hand A mano Von Hand Com a mão A mano Met de hand À la main</p>		<p>Optional Opcional Optional Opcional Opzionale Optie En option</p>
	<p>Hex-Head Wrench Llave de cabeza hexagonal Sechskantschlüssel Chave de cabeça sextavada Chiave esagonale Zeskantsleutel Clé à tête hexagonale</p>		<p>Security Wrench Llave de seguridad Sicherheitsschlüssel Chave de segurança Chiave di sicurezza Veiligheidssleutel Clé de sécurité</p>

TOOLS REQUIRED FOR INSTALLATION

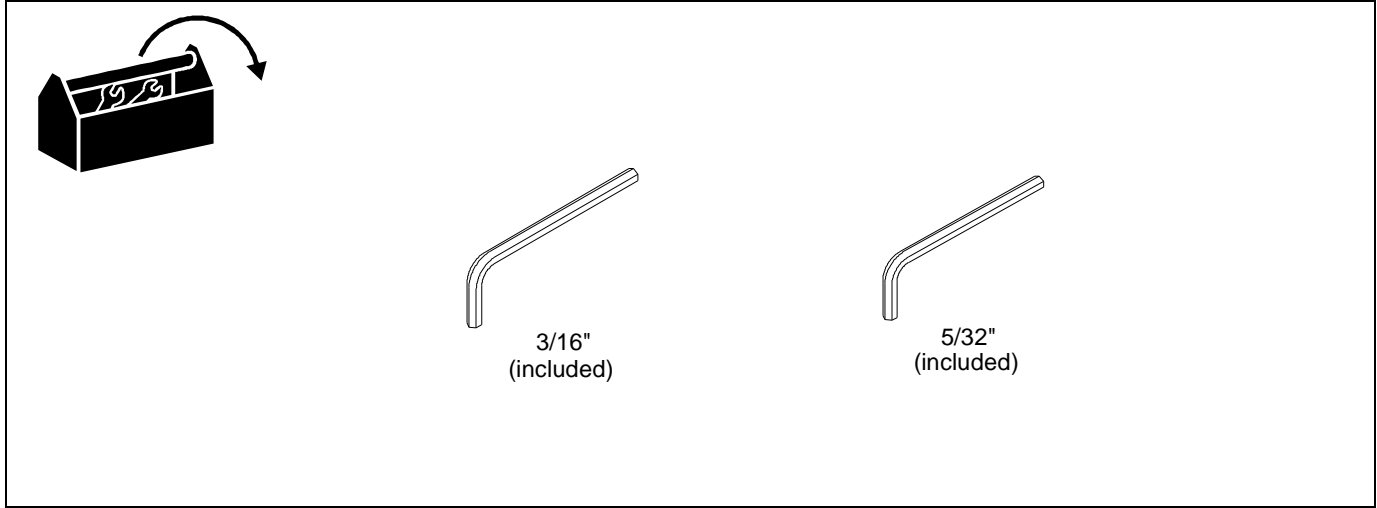

PARTS

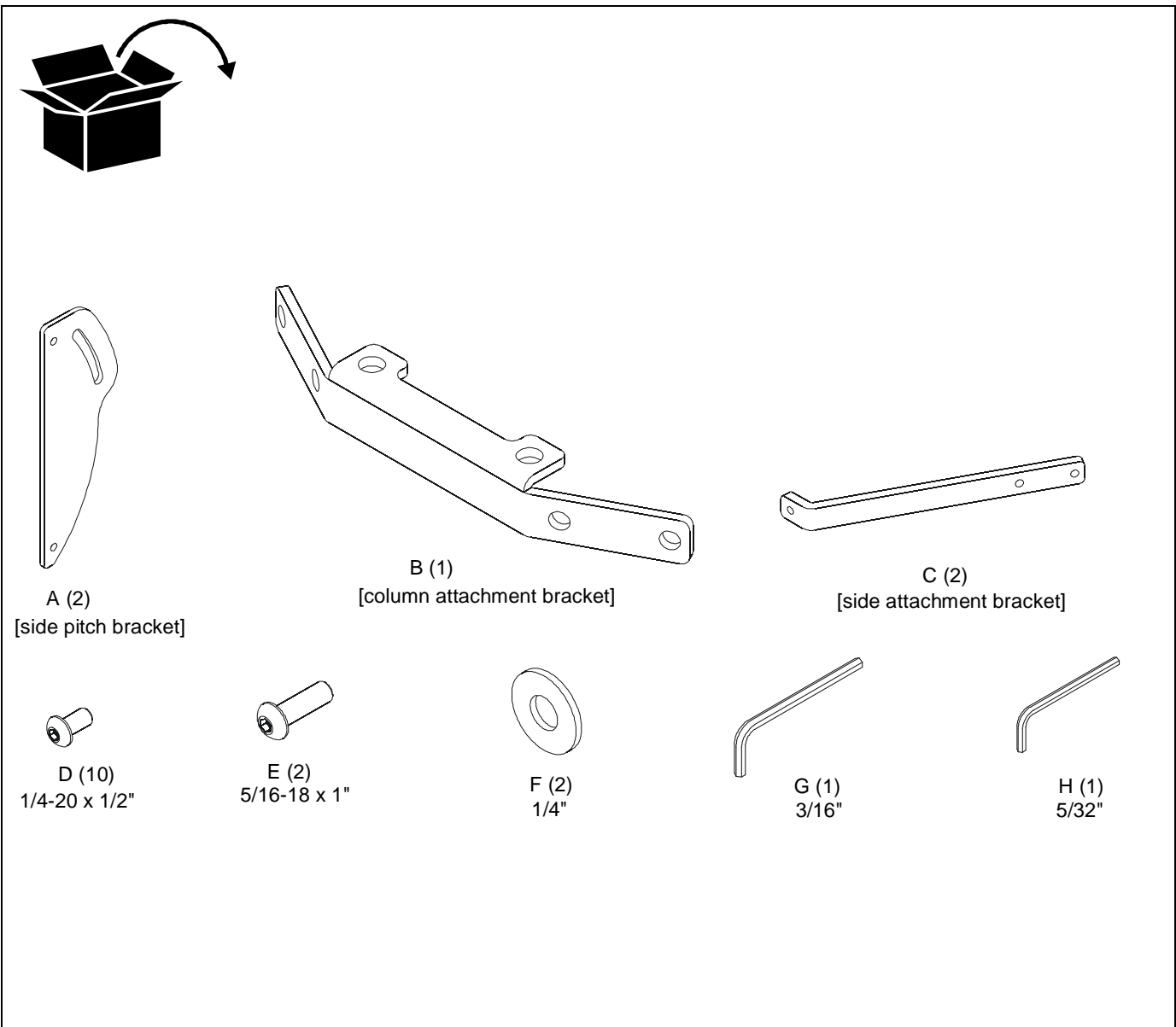

Bracket Installation

1. Assemble cart assembly according to installation instructions included with cart.
2. Remove rear two 5/16-18 x 3/4" button head cap screws from cart stand. (See Figure 1)

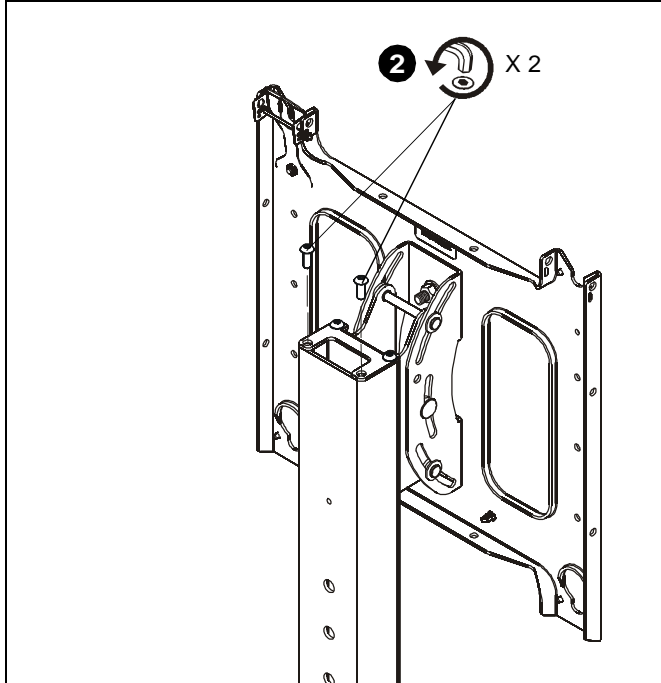

Figure 1

3. Connect two side pitch brackets (A) to faceplate using four 1/4-20 x 1/2" button head cap screws (D). (See Figure 2)

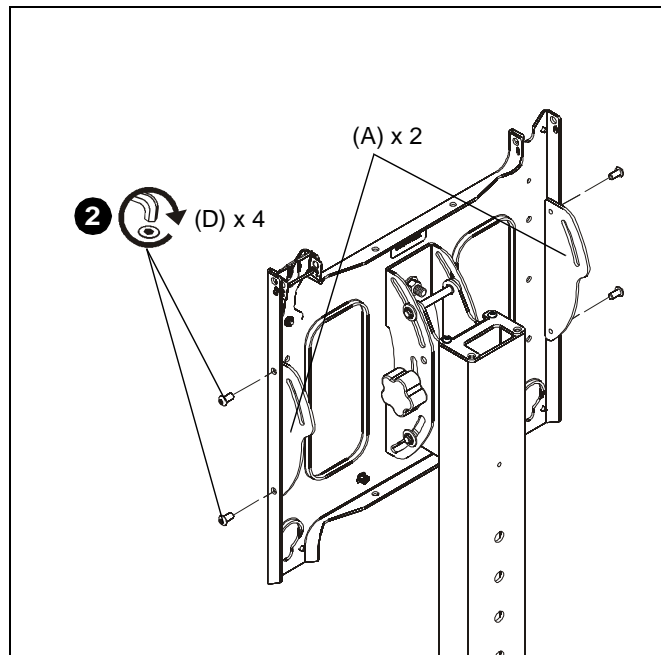

Figure 2

4. Connect column attachment bracket (B) to side attachment brackets (C) using four 1/4-20 x 1/2" button head cap screws (D). (See Figure 4)

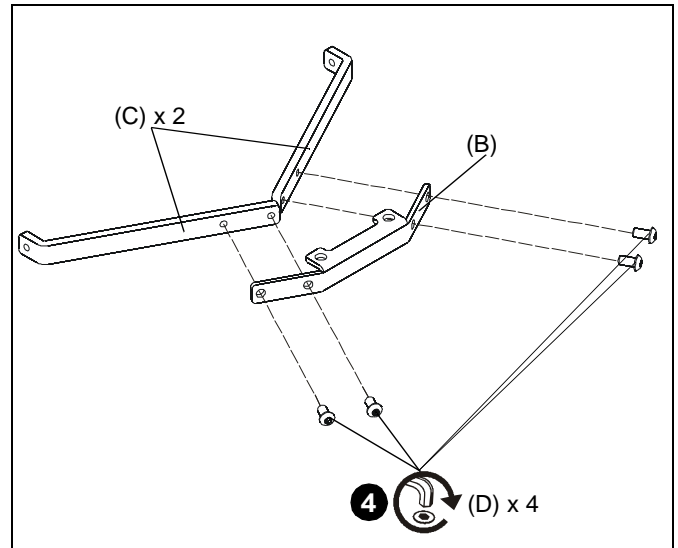

Figure 3

5. Secure column attachment bracket (B) to cart column using two 5/16-18 x 1" button head cap screws (E). (See Figure 4)
6. Use pitch adjustment knob to adjust pitch to desired level. (See Figure 4)
7. Connect two side attachment brackets (C) to side pitch brackets (A) using two 1/4-20 x 1/2" button head cap screws (D) and two 1/4" washers. (See Figure 4)

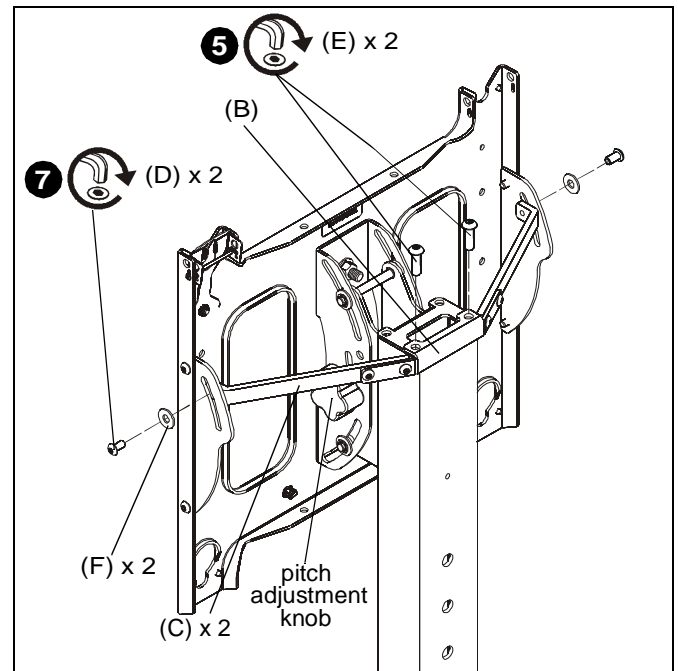

Figure 4

Pitch Adjustment

1. Loosen two 1/4-20 x 1/2" button head cap screws (D) locking pitch position of the mount. (See Figure 5)
2. Use pitch adjustment knob to adjust pitch to desired level. (See Figure 5)
3. Tighten two 1/4-20 x 1/2" button head cap screws (D) to lock pitch position back into place. (See Figure 5)

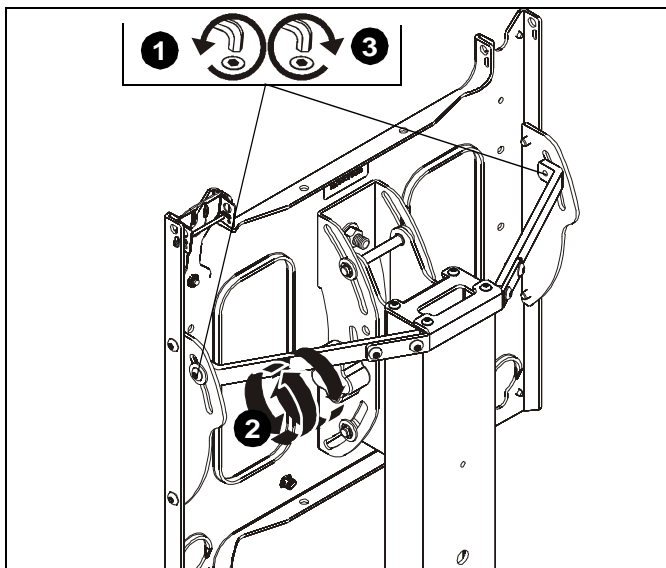

Figure 5



Our Mounts. **Your Vision.**

Chief Manufacturing, a products division
of Milestone AV Technologies

8800-002082 Rev00
©2011 Milestone AV Technologies, a
Duchossois Group Company
www.chiefmfg.com
04/11

USA/International	A 8401 Eagle Creek Parkway, Savage, MN 55378 P 800.582.6480 / 952.894.6280 F 877.894.6918 / 952.894.6918
Europe	A Fellenoord 130 5611 ZB EINDHOVEN, The Netherlands P +31 (0)40 2668620 F +31 (0)40 2668615
Asia Pacific	A Office No. 1 on 12/F, Shatin Galleria 18-24 Shan Mei Street Fotan, Shatin, Hong Kong P 852 2145 4099 F 852 2145 4477

