

INSTALLATION INSTRUCTIONS

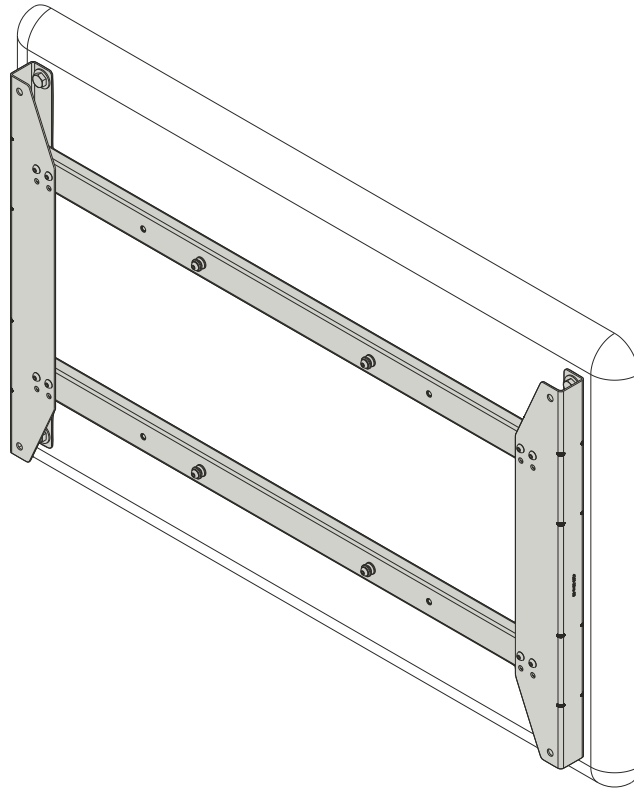

Large Width Flat Panel Interface Bracket

DISCLAIMER

Milestone AV Technologies and its affiliated corporations and subsidiaries (collectively "Milestone"), intend to make this manual accurate and complete. However, Milestone makes no claim that the information contained herein covers all details, conditions or variations, nor does it provide for every possible contingency in connection with the installation or use of this product. The information contained in this document is subject to change without notice or obligation of any kind. Milestone makes no representation of warranty, expressed or implied, regarding the information contained herein. Milestone assumes no responsibility for accuracy, completeness or sufficiency of the information contained in this document.

Chief® is a registered trademark of Milestone AV Technologies. All rights reserved.

DEFINITIONS

MOUNTING SYSTEM: A MOUNTING SYSTEM is the primary Chief product to which an accessory and/or component is attached.

ACCESSORY: AN ACCESSORY is the secondary Chief product which is attached to a primary Chief product, and may have a component attached or setting on it.

COMPONENT: A COMPONENT is an audiovisual item designed to be attached or resting on an accessory or mounting system such as a video camera, CPU, screen, display, projector, etc.



WARNING: A WARNING alerts you to the possibility of serious injury or death if you do not follow the instructions.



CAUTION: A CAUTION alerts you to the possibility of damage or destruction of equipment if you do not follow the corresponding instructions.



IMPORTANT SAFETY INSTRUCTIONS



WARNING: Failure to read, thoroughly understand, and follow all instructions can result in serious personal injury, damage to equipment, or voiding of factory warranty! It is the installer's responsibility to make sure all accessories are properly assembled and installed using the instructions provided.



WARNING: Failure to provide adequate structural strength for this accessory can result in serious personal injury or damage to equipment! It is the installer's responsibility to make sure the structure to which this accessory is attached can support five times the combined weight of all equipment. Reinforce the structure as required before installing the accessory. The wall to which the accessory is being attached may have a maximum drywall thickness of 5/8" (1.6cm). Do not install drywall anchors into the seam between drywall pieces.



WARNING: Exceeding the weight capacity can result in serious personal injury or damage to equipment! It is the installer's responsibility to make sure the combined weight of all components attached to accessory does not the weight limit of the mount to which it is attached.



WARNING: Use this accessory only for its intended use as described in these instructions. Do not use attachments not recommended by the manufacturer.



WARNING: Never operate this accessory if it is damaged. Return the mounting system to a service center for examination and repair.



WARNING: Do not use this product outdoors.

--SAVE THESE INSTRUCTIONS--

DIMENSIONS

PSB2088

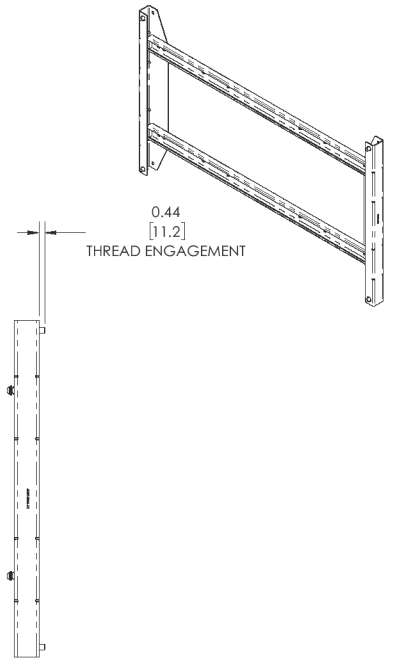
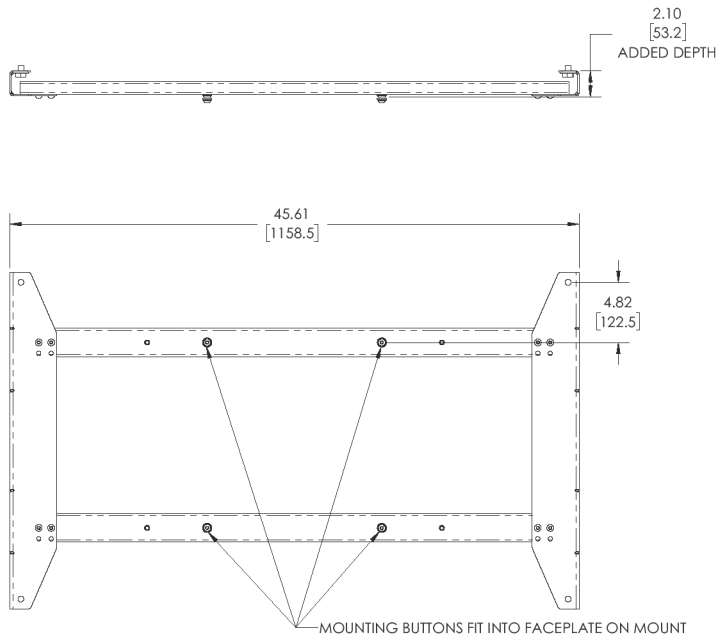

FHB5088

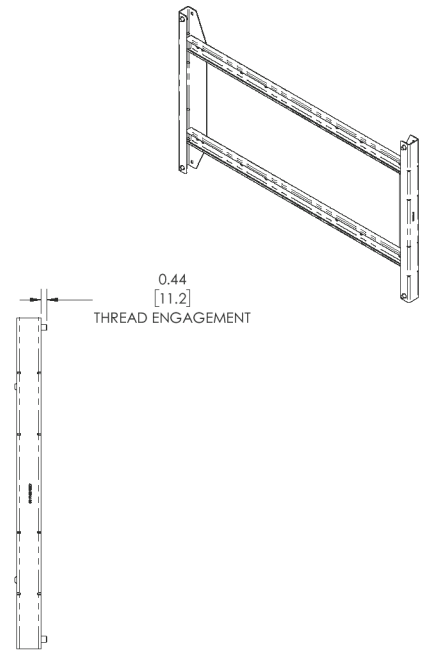
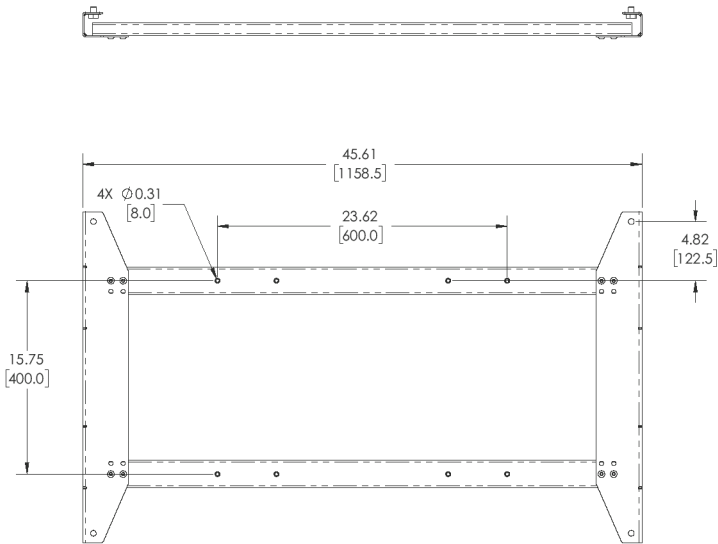

TOOLS / PARTS FOR INSTALLATION

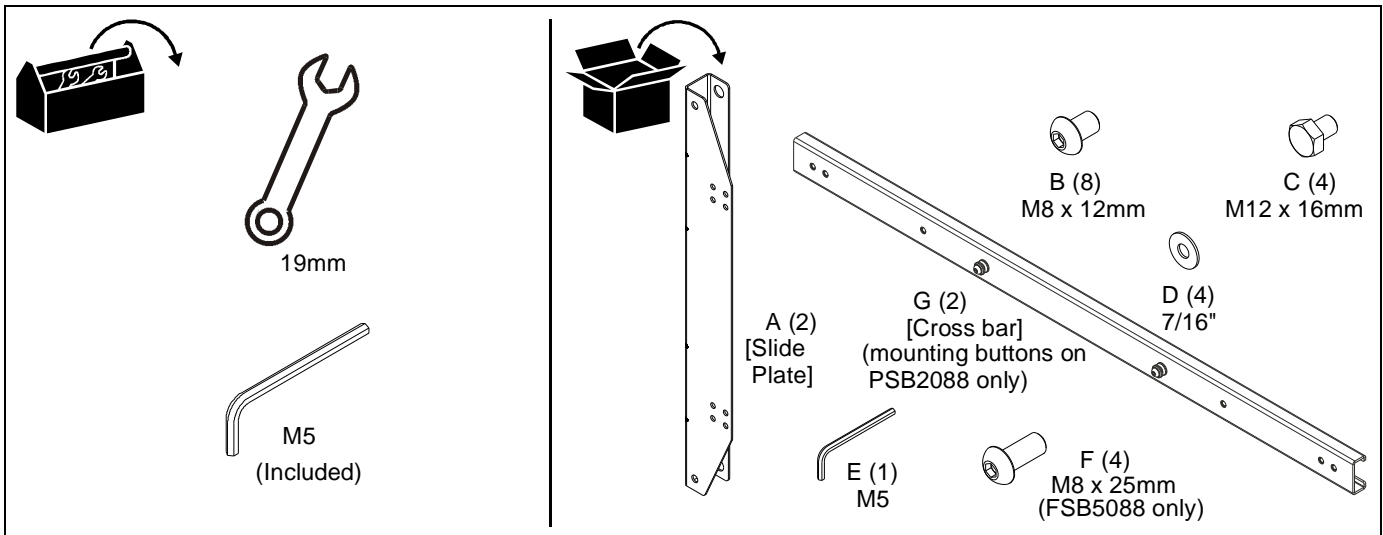

ASSEMBLY AND INSTALLATION

1. Use eight M8 x 12mm button head cap screws (B) and M5 hex key (E) to secure two side plates (A) to two cross bars (G). (See Figure 1)

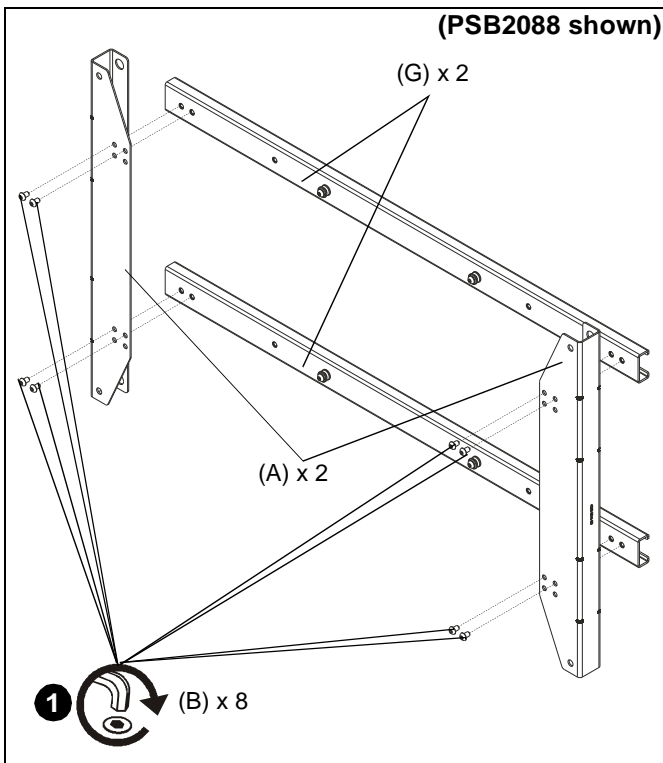

Figure 1

2. Attach vertical brackets (A) to back of display using four M12 x 16mm hex head cap head screws (C) and four 7/16" washers (D). (See Figure 2)

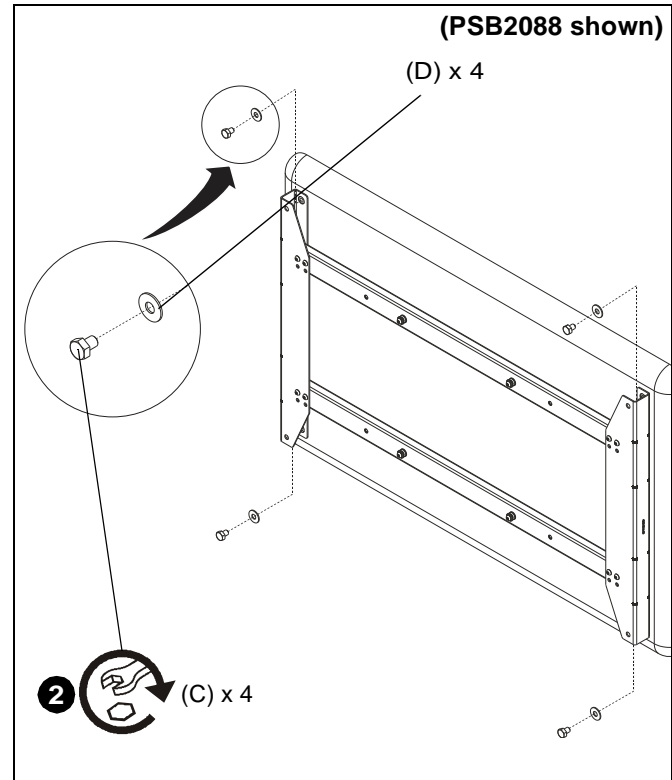

Figure 2

3. Complete the installation following the mount installation instructions.



Our Mounts. **Your Vision.**

Chief, a products division of
Milestone AV Technologies

8800-003016 Rev00
©2018 Milestone AV Technologies
www.milestone.com
03/18

USA/International	A 6436 City West Parkway, Eden Prairie, MN 55344 P 800.582.6480 / 952.225.6000 F 877.894.6918 / 952.894.6918
Europe	A Franklinstraat 14, 6003 DK Weert, Netherlands P +31 (0) 495 580 852 F +31 (0) 495 580 845
Asia Pacific	A Office No. 918 on 9/F, Shatin Galleria 18-24 Shan Mei Street Fotan, Shatin, Hong Kong P 852 2145 4099 F 852 2145 4477

