



INSTALLATION INSTRUCTIONS

PSB-2132

PLASMA DISPLAY MOUNTING BRACKET

Prior to assembly, unpack carton completely and verify contents.

If you are missing any of the following components, please contact Customer Service at 1-800/582-6480

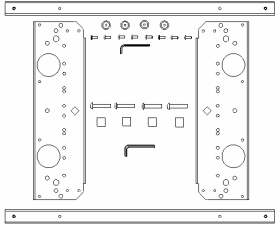

Figure 1

- (2) Plasma Side Bracket
- (4) Mounting Button - Tapped
- (4) .74 x .39 x 1.0 Nylon Spacer
- (4) M8 x 50mm Button Head Cap Screw
- (1) M5 Allen Key

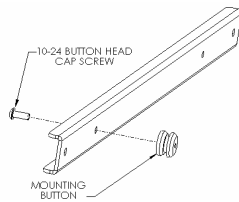

Figure 2

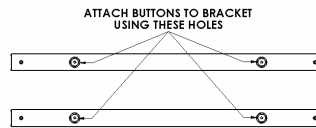

Figure 3

- (2) Plasma Top/Bottom Bracket
- (8) 10-24 x .5 Button Head Cap Screw
- (4) M8 x 40mm Button Head Cap Screw
- (1) 1/8 Allen Key

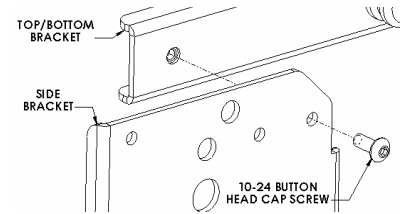

Figure 4

BEFORE PROCEEDING, READ INSTALLATION INSTRUCTIONS COMPLETELY

CAUTION! PLASMA DISPLAYS ARE EXTREMELY FRAGILE.

1. Using a 10-24 button head cap screw inserted from back side of bracket, secure mounting button, with chamfered hole of mounting button (larger surface) facing bracket, to top and bottom brackets (four places) (see Figure 2 & Figure 3).
2. Using four 10-24 button head cap screws, attach top and bottom to side brackets (see Figure 4 & Figure 5).
3. Place Nylon spacers over mounting holes on back of screen. Attach mounting brackets to display using M8 screws (see Figure 6 & Figure 7). Use correct length of screws depending on thread depth of screen.
4. With the aid of another person, lift your display up to the Chief Mount, aligning buttons of mounting brackets with slots in the Chief Mount.
5. Lower safety latch on the Chief Mount to secure your display, making sure latch is completely engaged.

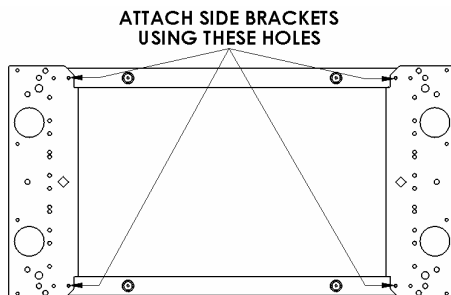

Figure 5

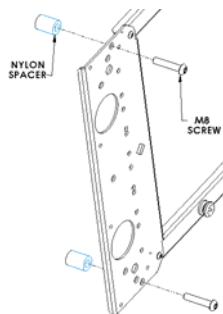

Figure 6

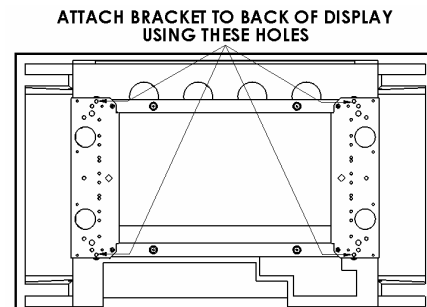

Figure 7