

INSTALLATION INSTRUCTIONS

PSB-2157 DISPLAY MOUNTING BRACKET

Prior to assembly, unpack carton completely and verify contents.

If you are missing any of the following components, please contact Customer Service at 1-800/582-6480

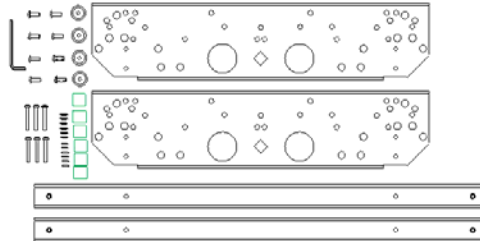

Figure 1

- | | |
|-----------------------------------|--------------------------------------|
| (2) Side Bracket | (2) Top/Bottom Bracket |
| (4) Mounting Button - Tapped | (8) 10-24 x .5 Button Head Cap Screw |
| (6) .68 x .39 x .625 Nylon Spacer | (6) M4 x 30 Phillips Head Cap Screw |
| (6) Nylon Shoulder Washer | (6) M4 Flat Washer |
| (1) 1/8" Allen Key | |

BEFORE PROCEEDING, READ INSTALLATION INSTRUCTIONS COMPLETELY

CAUTION! DISPLAYS ARE EXTREMELY FRAGILE.

WARNING!

ALL COMPONENTS MUST BE SECURELY FASTENED TO A STRUCTURAL MEMBER CAPABLE OF SUPPORTING 4 TIMES THE COMBINED WEIGHT OF ALL COMPONENTS PLUS THE EQUIPMENT BEING MOUNTED. IF IT CANNOT SUPPORT THIS WEIGHT, THE STRUCTURE MUST BE REINFORCED. THE MAXIMUM WEIGHT TO BE INSTALLED ON THE MOUNT IS 175 POUNDS (79.38 KG).

1. Using a 10-24 button head cap screw inserted from back side of bracket, secure mounting button, with chamfered hole of mounting button (larger surface) facing bracket, to top and bottom brackets (four places) (see Figure 2 & Figure 3).
2. Using four 10-24 button head cap screws, attach top and bottom to side brackets (see Figure 4 & Figure 5).

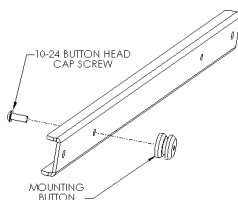

Figure 2

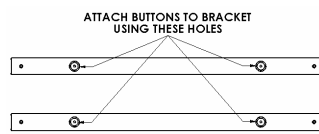

Figure 3

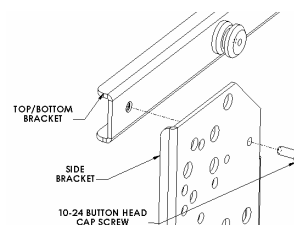

Figure 4

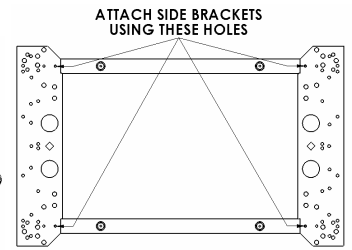

Figure 5

3. Place Nylon spacers over the mounting holes on back of screen. Attach mounting brackets to display using the M4 screws, shoulder washers and flat washers (See Figure 6 & Figure 7).
4. With the aid of another person, lift your display up to the Chief Mount, aligning buttons of mounting brackets with slots in the Chief Mount.
5. Lower safety latch on the Chief Mount to secure your display, making sure latch is completely engaged.

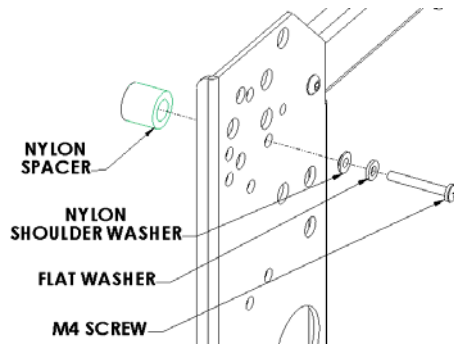

Figure 6

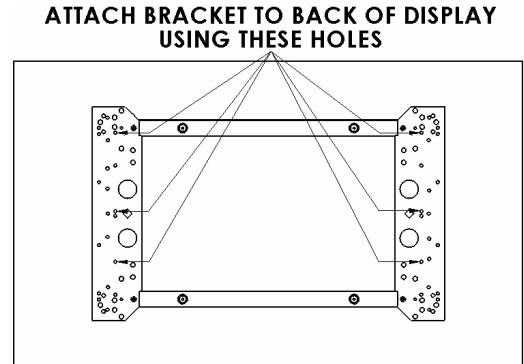

Figure 7