

INSTALLATION INSTRUCTIONS

PSB-2570 DISPLAY MOUNTING BRACKET

Prior to assembly, unpack carton completely and verify contents.

If you are missing any of the following components, please contact Customer Service at 1-800/582-6480

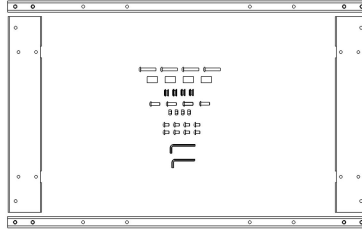

Figure 1

- (2) Side Bracket
- (4) Mounting Buttons – Black Zinc
- (4) 5/16 – 18 Nylock Nut
- (4) M8 x 45 mm Button Head Cap Screw
- (1) 3/16" Allen Key

- (2) Spanning Bracket
- (4) 5/16 – 18 x 1.0 Button Head Cap Screw
- (8) 5/16 – 18 x .5 Button Head Cap Screw
- (4) M18 x M8.3 x M30 Nylon Spacer
- (1) M5 Allen Key

BEFORE PROCEEDING, READ INSTALLATION INSTRUCTIONS COMPLETELY

CAUTION! **DISPLAYS ARE EXTREMELY FRAGILE.**

ALL COMPONENTS MUST BE SECURELY FASTENED TO A STRUCTURAL MEMBER CAPABLE OF SUPPORTING 4 TIMES THE COMBINED WEIGHT OF ALL COMPONENTS PLUS THE EQUIPMENT BEING MOUNTED. IF IT CANNOT SUPPORT THIS WEIGHT, THE STRUCTURE MUST BE REINFORCED.

WARNING! **THE MAXIMUM WEIGHT TO BE INSTALLED ON THE MOUNT IS 200 POUNDS (90.72 KG).**

1. Using a 5/16-18 button head cap screw inserted from back side of bracket and Nylock nut, secure mounting button, with chamfered hole of mounting button (larger surface) facing bracket, to side brackets (four places) (see Figure 2 & Figure 3). Make sure bends of interface bracket face away from buttons. If using PSH or PPH Heavy-Duty mounts, attach buttons using outer (24" on center) holes.

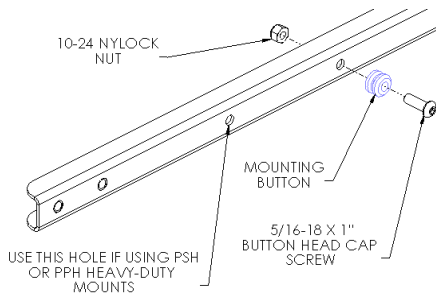

Figure 2

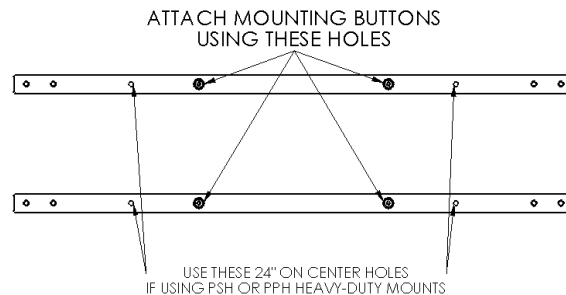

Figure 3

- Using eight 5/16-18 x .5" button head cap screws, attach spanning brackets to sides (see Figure 4 & Figure 5).

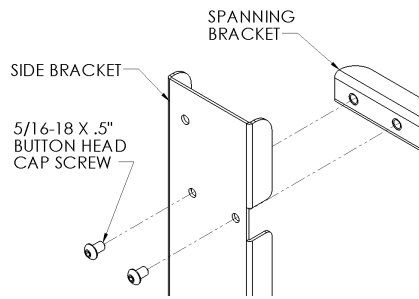

Figure 4

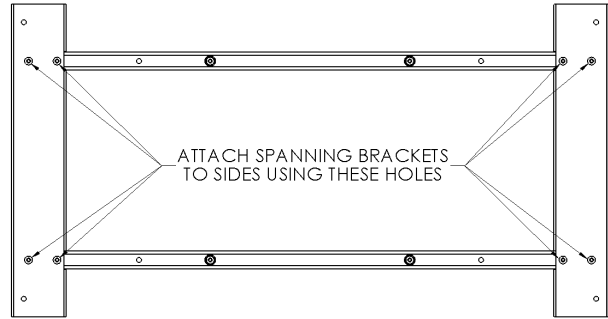

Figure 5

- Place Nylon spacers over mounting holes on back of screen. Attach mounting brackets to the display using the M8 screws (see Figure 6 & Figure 7).
- With the aid of another person, lift your display up to the Chief Mount, aligning buttons of mounting brackets with slots in the Chief Mount. If using PSH or PPH Heavy-Duty mount, make sure teardrop slots of mount are in 24" x 14" configuration.
- Lower safety latch on the Chief Mount to secure your display, making sure latch is completely engaged.

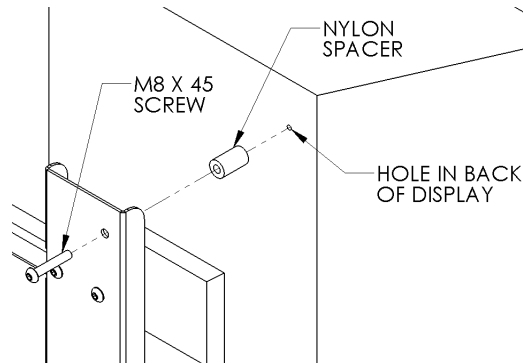

Figure 6

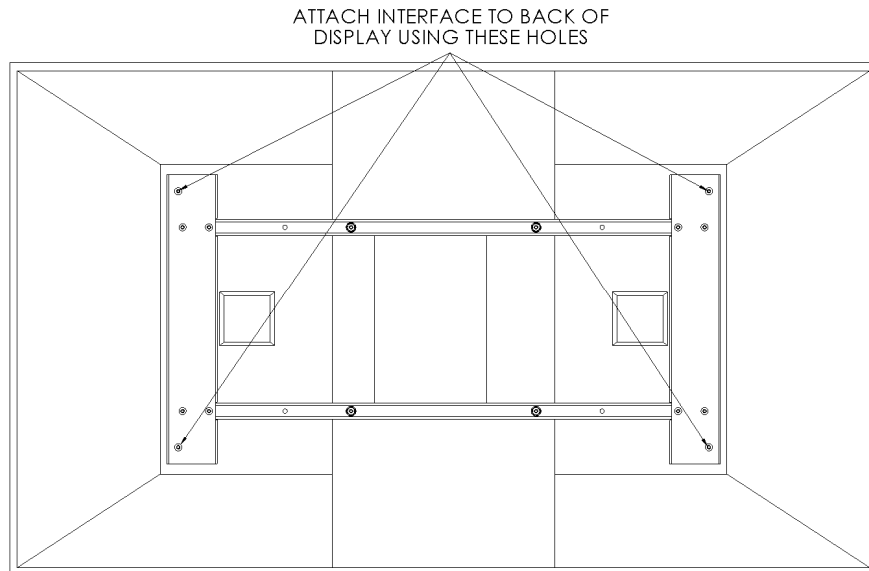

Figure 7