

---

# INSTALLATION INSTRUCTIONS

---

## DISPLAY STATIC MOUNT PSM-2031

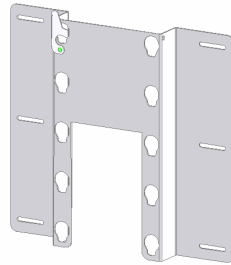

Figure 1

- |  |                       |
|--|-----------------------|
| (1) Static Mount Bracket                 | (10) Mounting Buttons |
| (10) M6 x 30 mm Phillips Head Cap Screws | (1) Nylon Washer      |
| (1) Latching Flag                        | (1) 10-24 Nylock Nut  |
| (1) 10-24 x .5 Flat Head Undercut Screw  | (10) Flat Washers     |

**BEFORE PROCEEDING:** Unpack the carton, verify contents shown in Figure 1 and read installation instructions completely. If you are missing any of the listed components, please contact Customer Service at 1-800/582-6480.

### **CAUTION!** Displays are Extremely Fragile.

1. Attach latching flag to mount using the 10-24 Phillips flat head screw, Nylon washer, and Nylock nut (see Figure 2). Tighten until friction will hold the flag in place.

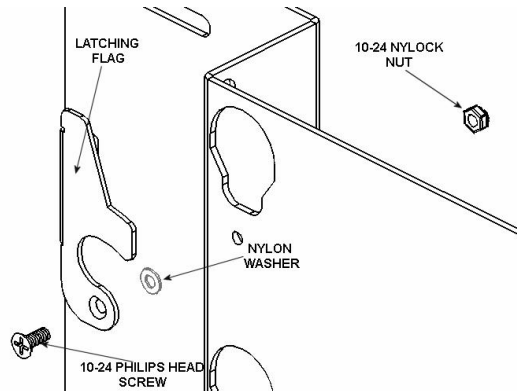

Figure 2

2. Attach mounting buttons to display using the appropriate number of M6 x 30 mm screws and flat washers provided (See Figures 3, 4, and 5).



**CHIEF MANUFACTURING INC.**  
1-800-582-6480 952-894-6280 FAX 952-894-6918  
8401 EAGLE CREEK PKWY, STE. 700  
SAVAGE, MINNESOTA 55378 USA

8805-000195 Rev01  
2004 Chief Manufacturing  
[www.chiefmfg.com](http://www.chiefmfg.com)  
08/06

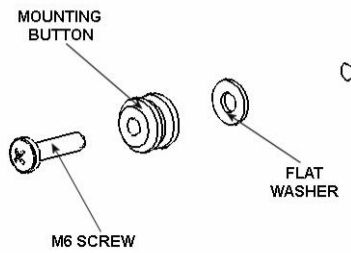

Figure 3

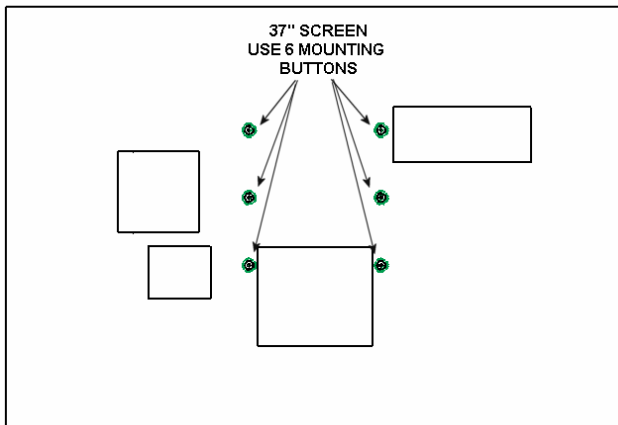

Figure 4

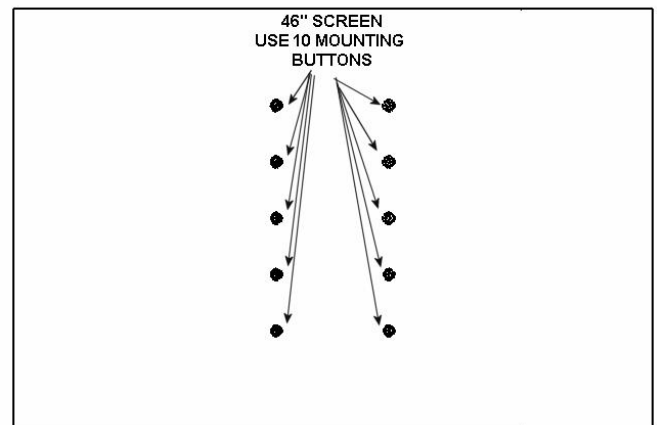

Figure 5

# WARNING

**ALL COMPONENTS MUST BE SECURELY FASTENED TO A STRUCTURAL MEMBER CAPABLE OF SUPPORTING 4 TIMES THE COMBINED WEIGHT OF ALL COMPONENTS PLUS THE EQUIPMENT BEING MOUNTED. IF IT CANNOT SUPPORT THIS WEIGHT, THE STRUCTURE MUST BE REINFORCED. THE MAXIMUM WEIGHT TO BE INSTALLED ON THE MOUNT IS 175 POUNDS (79.38 KG).**

3. Securely anchor the static mount to wall studs or supporting framework (see WARNING).
4. Make sure the flag is lowered before attempting to place the screen on the mount.

5. With the aid of another person, lift the display up to the mount, align the mounting buttons on the screen with the teardrop slots in the mount, and set the screen into place (see Figure 5).

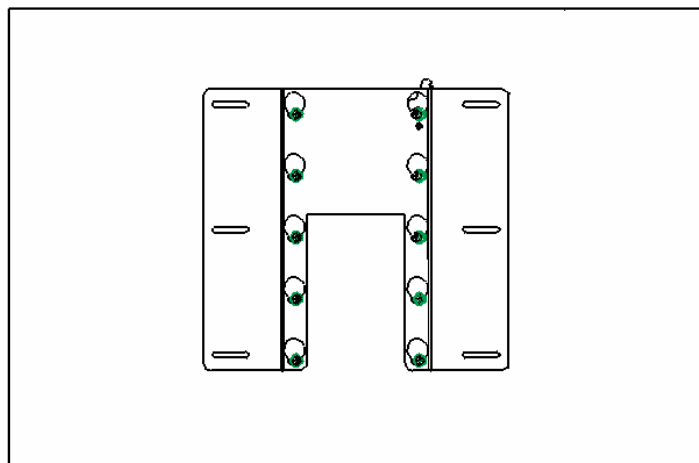

Figure 5

6. Position (raise) the flag to secure the display (See Figure 6). There is a hole in the side of the mount that aligns with the flag. If desired, a padlock can be used to secure the screen through this hole.

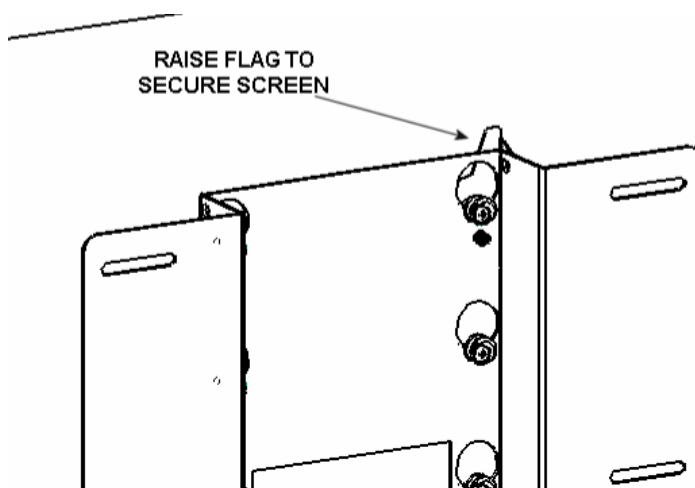

Figure 6