

INSTALLATION INSTRUCTIONS

PLASMA DISPLAY STATIC MOUNT PSM-2091, PSM-2092, & PSM-2095

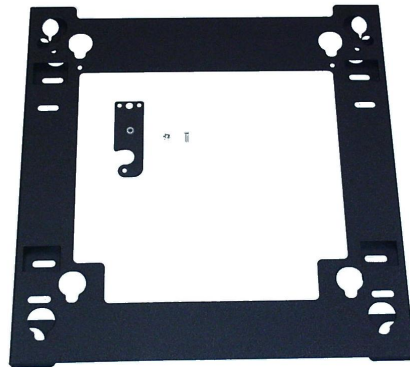

Figure 1

(1) Plasma Static Mount
(1) Latching Flag
(1) Nylon Washer

(1) 10-24 x .5 FH Socket Screw
(1) 10-24 Nylock Nut

BEFORE PROCEEDING: Unpack the carton, verify contents shown in Figure 1 and read installation instructions completely. If you are missing any of the listed components, please contact Customer Service at 1-800/582-6480.

CAUTION! PLASMA DISPLAYS ARE EXTREMELY FRAGILE.

The PSM 2091, 2092, and 2095 is designed so one mount will work for the Sony PFM32, Sony PFM42, and Sony PFM50 plasma displays. There are 3 mounting patterns on the mount corresponding to the mounting button pattern on the back of the respective plasma. On one side of the mount has patterns for the 32 and 42-inch plasma and the other side has the mounting pattern for the 50-inch plasma. The latching flag must be attached to the mount in the proper location for each individual plasma.

1. Attach latching flag to mount utilizing the proper position on the mount with the latching flag on the inside of the mount. Tighten Nylock nut until friction is sufficient to hold the latch in place (see Figure 2, Figure 3, Figure 4, & Figure 5).

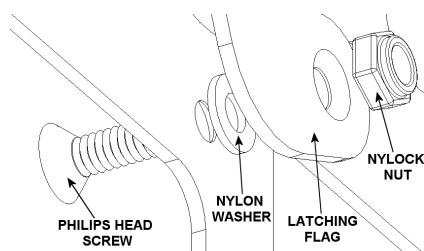

Figure 2

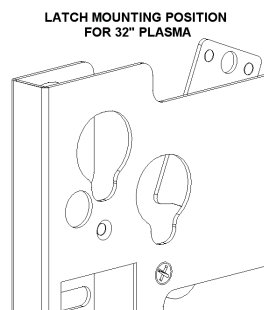

Figure 3

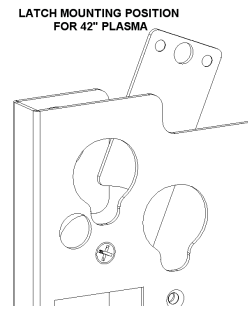

Figure 4

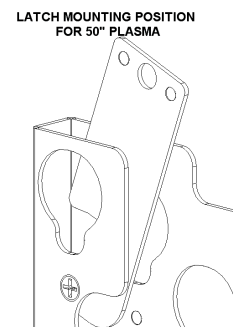

Figure 5



CHIEF MANUFACTURING INC.
1-800-582-6480 952-894-6280 FAX 952-894-6918
12800 HIGHWAY 13 SOUTH, SUITE 500
SAVAGE, MINNESOTA 55378 USA

8805-000043 Rev01
2003 Chief Manufacturing
www.chiefmfg.com
01/03

WARNING!

ALL COMPONENTS MUST BE SECURELY FASTENED TO A STRUCTURAL MEMBER CAPABLE OF SUPPORTING 4 TIMES THE COMBINED WEIGHT OF ALL COMPONENTS PLUS THE EQUIPMENT BEING MOUNTED. IF IT CANNOT SUPPORT THIS WEIGHT, THE STRUCTURE MUST BE REINFORCED.

THE MAXIMUM WEIGHT TO BE INSTALLED ON THE MOUNT IS 150 POUNDS (68.04 KG).

2. Mount plasma static mount onto wall utilizing wall studs or supporting framework with the proper face of the mount away from the wall for the respective plasma (see WARNING, Figure 6, & Figure 7).

ATTACH MOUNT TO WALL IN THIS MANNER FOR THE 32 AND 42 INCH PLASMAS

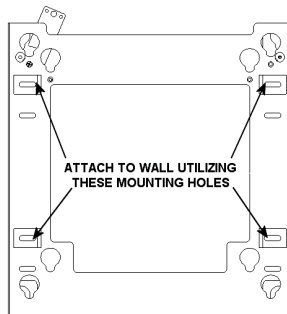

Figure 6

ATTACH MOUNT TO WALL IN THIS MANNER FOR THE 50" PLASMA

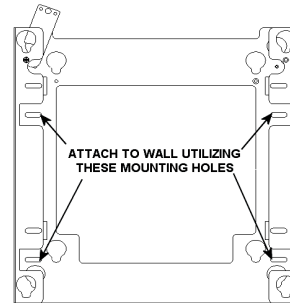

Figure 7

3. Turn latching flag to the side prior to placing plasma in place.
4. With the aid of another person, lift plasma display up to the Chief mount, aligning mounting buttons with the teardrop slots dependent upon the model plasma (see Figure 8 & Figure 9).

USE INSIDE SLOTS FOR 32" PLASMA
USE OUTSIDE SLOTS FOR 42" PLASMA

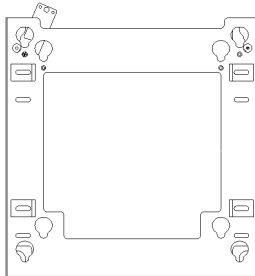

Figure 8

RAISE LATCH TO SECURE PLASMA

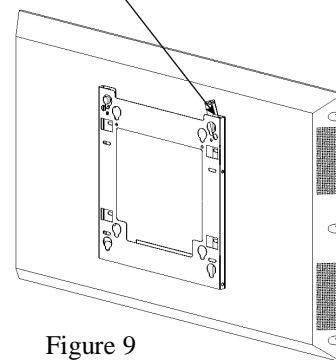

Figure 9

5. Raise safety latch to secure plasma in place (see Figure 10).

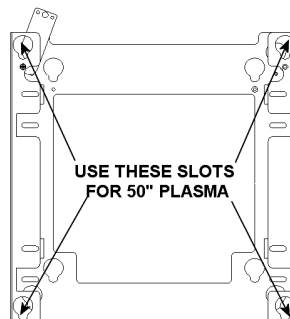

Figure 10