

INSTALLATION INSTRUCTIONS

DISPLAY STATIC MOUNT PSM-2158

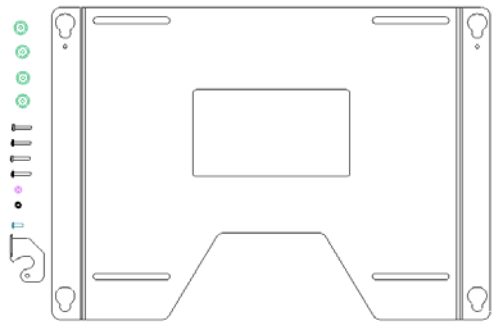

Figure 1

- | | |
|--|--|
| (1) Static Mount | (1) 10-24 x .5 Phillips Head Cap Screw |
| (1) Latching Flag | (1) Nylon Washer |
| (4) M5 X 25mm Phillips Head Cap Screws | (1) 10-24 Nylock Nut |
| (4) Mounting Buttons | |

BEFORE PROCEEDING: Unpack the carton, verify contents shown in Figure 1 and read installation instructions completely. If you are missing any of the listed components, please contact Customer Service at 1-800/582-6480.

CAUTION! Displays are Extremely Fragile.

1. Attach latching flag to mount using the 10-24 screw, Nylon washer, and Nylock nut (see Figure 2). Tighten until friction will hold the flag in place.
2. Attach mounting buttons to the display using the M5 screws provided (see Figure 3 & Figure 4).

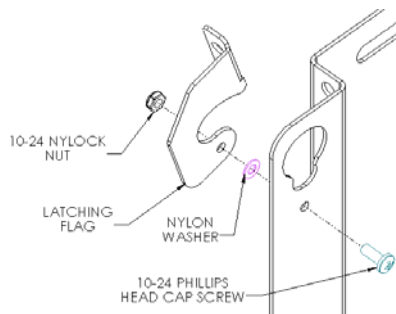

Figure 2

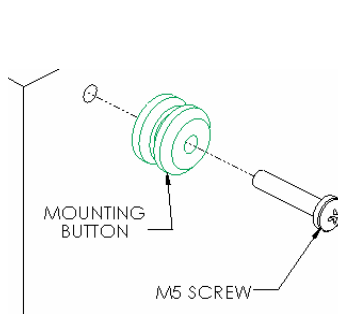

Figure 3

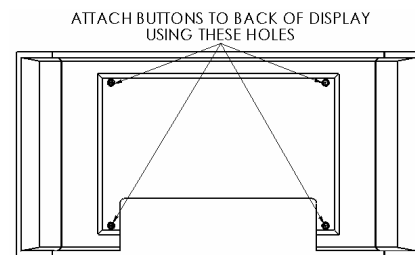

Figure 4

WARNING

ALL COMPONENTS MUST BE SECURELY FASTENED TO A STRUCTURAL MEMBER CAPABLE OF SUPPORTING FOUR TIMES THE COMBINED WEIGHT OF ALL COMPONENTS PLUS THE EQUIPMENT BEING MOUNTED. IF IT CANNOT SUPPORT THIS WEIGHT, THE STRUCTURE MUST BE REINFORCED.

THE MAXIMUM WEIGHT TO BE INSTALLED ON THE MOUNT IS 175 POUNDS (79.38 KG).

3. Securely anchor the static mount to wall studs or supporting framework (see WARNING).
4. Make sure the flag is lowered to the side before attempting to place the display on the mount.
5. With the aid of another person, lift the display up to the mount, align the mounting buttons on the display with the teardrop slots in the mount, and set the display into place (see Figure 5).
6. Position (raise) the flag to secure the display. Use padlock (not supplied) to secure flag to mount if needed (see Figure 6).

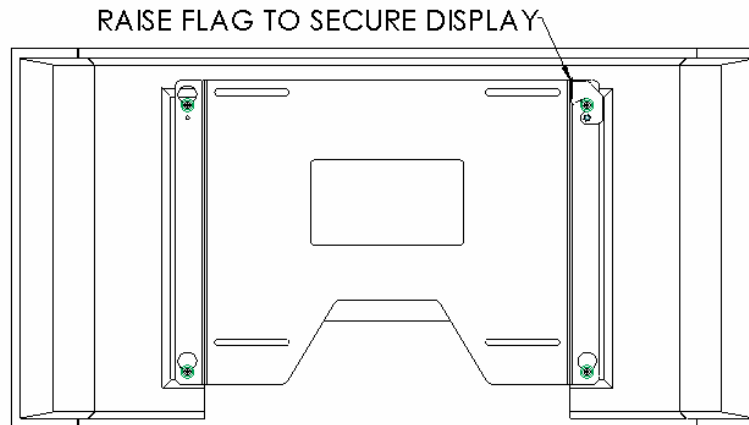

Figure 5

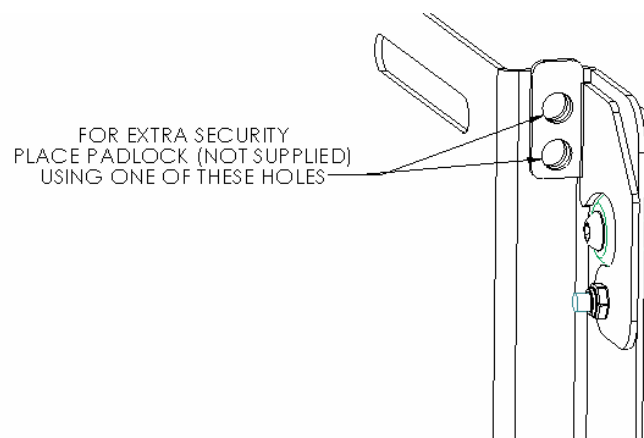

Figure 6