

INSTRUCTION MANUAL

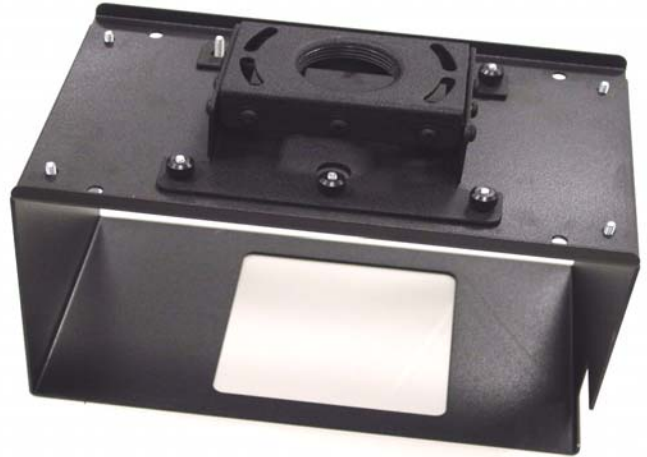

The Christie Vivid Green ceiling mount will suspend your Christie Vivid Green projector in an upright position to compliment conference rooms, classrooms or home theater installations. This mount can be attached using a standard NPT 1 1/2" pipe column, an adjustable column, or flush mounted.



BEFORE YOU BEGIN

- **CAUTION:** To prevent damage to the mount, which could affect or void the Factory warranty, thoroughly study all instructions and illustrations before you begin to install the mount. Pay particular attention to the "Important Precautions" on Page 1.
- If you have any questions about this installation, see the back page of this manual for contact information.



IMPORTANT WARNINGS AND CAUTIONS!

- WARNING:** A **WARNING** alerts you to the possibility of serious injury or death if you do not follow the instructions.
- CAUTION:** A **CAUTION** alerts you to the possibility of damage or destruction of equipment if you do not follow the corresponding instructions.
- **WARNING: Improper installation can result in serious personal injury! Make sure that the ceiling structural members can support a redundant weight factor five times the total weight of the equipment. If the ceiling can not support this weight, reinforce the ceiling before installing the mount.**
 - **WARNING: Be aware also of the potential for personal injury or damage to the unit if it is not adequately mounted.**
 - **WARNING: The installer is responsible for verifying that the ceiling to which the mount is anchored will safely support the combined load of all attached components or other equipment.**
 - **WARNING: The weight of the projector must not exceed 40 lbs (18 kg), the maximum load capacity of the mount.**
 - **CAUTION:** To avoid personal injury or damage to the mount, be sure that it is installed square and parallel in all dimensions.
 - **CAUTION:** Check the unit for shipping damage before you begin the installation.

CONTENTS

TOOLS REQUIRED FOR INSTALLATION	1
MOUNT ASSEMBLY PROCEDURES	2
RPA INSTALLATION PROCEDURES.....	3
ADJUST YAW, PITCH AND ROLL	4
PARTS	6
DEALER INFORMATION	8
DIMENSIONAL DRAWING	9

TOOLS REQUIRED FOR INSTALLATION

- Phillips screwdrivers, No. 1 and No. 2 TIP
- Drill and bit set
- 3/8” Wrench

NOTE: Other tools may be required depending on the method of installation.

MOUNT ASSEMBLY PROCEDURES

Assemble the mount as follows:

1. Install four self adhesive round felt pads on each side of the square filter cutout in the cradle bracket (see Figure 1).

CAUTION: To avoid damage to the projector, spread sides of cradle bracket enough to prevent scratching or marring paint on the sides of the projector.

2. If necessary, carefully spread the vertical legs of the cradle and slide the projector into the cradle, aligning the filter hole cutout in the bracket with the filter door of the projector.
3. On the side facing the projector surface (opposite the surface with studs) of the hanger bracket, install four 1/2" diameter white rubber bumpers over four .21" diameter holes (see Figure 2).
4. Place the hanging bracket on the cradle with the four #10-24 X 1/2" long studs through the four .21" diameter outside holes (see Figure 3).
5. Using four #10-24 nylock nuts and flat washers, secure the hanging bracket to the cradle.

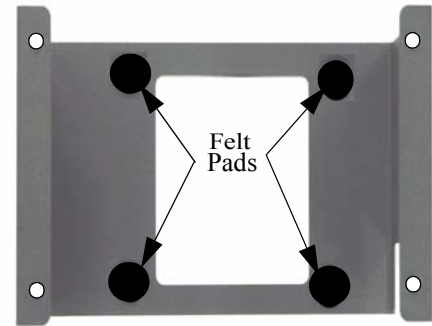

Figure 1. Attach Adhesive Round Felt Pads

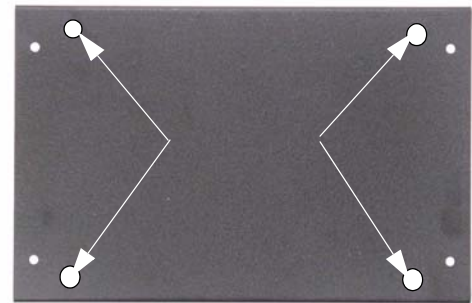

Figure 2. Install Bumpers (four places)



Figure 3. Secure Bracket to Cradle

RPA INSTALLATION PROCEDURES

There are two methods for installing the RPA. The RPA can be column mounted or surface mounted.

WARNING: Improper installation can cause serious personal injury! Make sure that the ceiling structural members can support a redundant weight factor *five times* the total weight of the equipment you intend to support overhead. The ceiling must be reinforced before you install the mount if the ceiling cannot support a redundant weight factor *five times* the total weight of the equipment.

Column Mount RPA

Install the RPA on a column as follows:

1. Thread the locking ring, tangs facing down, and RPA onto the threaded end of the column tube (see Figure 4 and Figure 5).
2. Using six studs on mount and six thumb screws, secure the RPA to the mount (see Figure 6).
3. Thread the locking ring against the RPA to lock the RPA in position and, if desired, route the cables through the RPA and pipe as shown in Figure 9.

Surface Mount RPA

Install the RPA as follows:

1. Disassemble the RPA:
 - a. Remove four #10-24 X 3/8" long pan head roll adjustment screws (see Figure 7).
 - b. Remove two #10-24 X 3/8" long pivot screws.
 - c. Remove the Ceiling bracket from the joint bracket (see Figure 8).
2. Secure the ceiling bracket to the wood framing member.
3. Secure the ceiling bracket to the joint bracket (see Figure 8) using four #10-24 X 3/8" long pan head roll adjustment screws and two #10-24 X 3/8" long pivot screws (see Figure 7).
4. Using six studs on mount and six thumb screws, secure the RPA to the mount (see Figure 7).
5. If desired, route cables through RPA as shown in Figure 9.

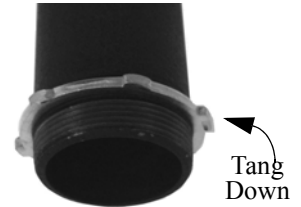

Figure 4. Thread Locking Ring on Column



Figure 5. Thread RPA on Column



Figure 6. RPA on Mount

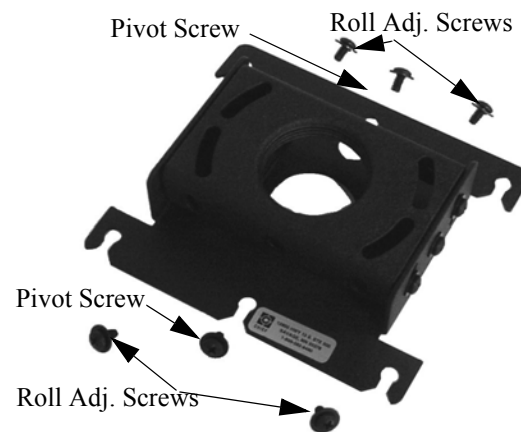

Figure 7. RPA Screws

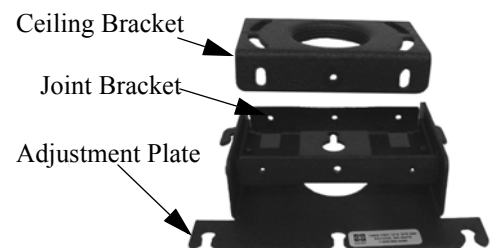

Figure 8. RPA Disassembly

ADJUST YAW, PITCH, AND ROLL

Adjust Yaw

Adjust Yaw as follows:

1. Loosen the 1 1/2" jam nut and back it off a couple of turns.

WARNING: When turning the mount in a counterclockwise direction, it may be completely unthreaded. The assembly could fall from the pipe.

2. Turn the assembly clockwise (raise) or counterclockwise (lower) to the desired yaw position.
3. Turn the jam nut down (counterclockwise) until it securely seats against the top cross member.

Adjust Pitch (Vertical Elevation)

Adjust pitch using the three #10-24X3/8" pitch adjustment screws located on each side of the adjustment plate. Adjust pitch as follows:

1. Loosen (slightly) three #10-24X3/8" pitch adjustment screws located on each side of the adjustment plate (see Figure 10).
2. Adjust projector angle to desired pitch.
3. Tighten three #10-24X3/8" pitch adjustment screws located on each side of the adjustment plate.

Adjust Roll

Adjust roll using the six #10-24X3/8" roll adjustment screws, three on the front and three on the back, of the adjustment plate. Adjust roll as follows:

1. Loosen (slightly) six #10-24X3/8" roll adjustment screws (see Figure 11).
2. Adjust projector to desired roll position.
3. Tighten six #10-24X3/8" roll adjustment screws.

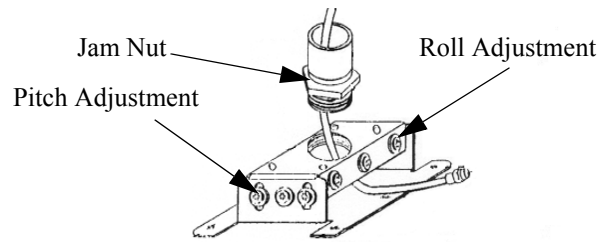

Figure 9. Adjust Yaw, Pitch, and Roll

Three pitch adjustment screws each side

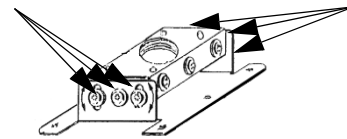

Figure 10. Adjust Pitch

Three roll adjustment screws each side

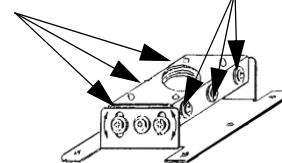

Figure 11. Roll Adjustment

THIS PAGE INTENTIONALLY BLANK

PARTS

Table 1: Parts

No.	Nomenclature	Qty.		No.	Nomenclature	Qty.
1	RPA	1		6	Bumpers, white, rubber	4
2	Ring, lock	1		7	Nuts, 10-24 Nylock	4
3	Bracket, hanging	1		8	Washer, #10, flat	4
4	Bracket, cradle	1		9	Nuts, thumb, 10-24	6
5	Pads, felt, round, adhesive	4				

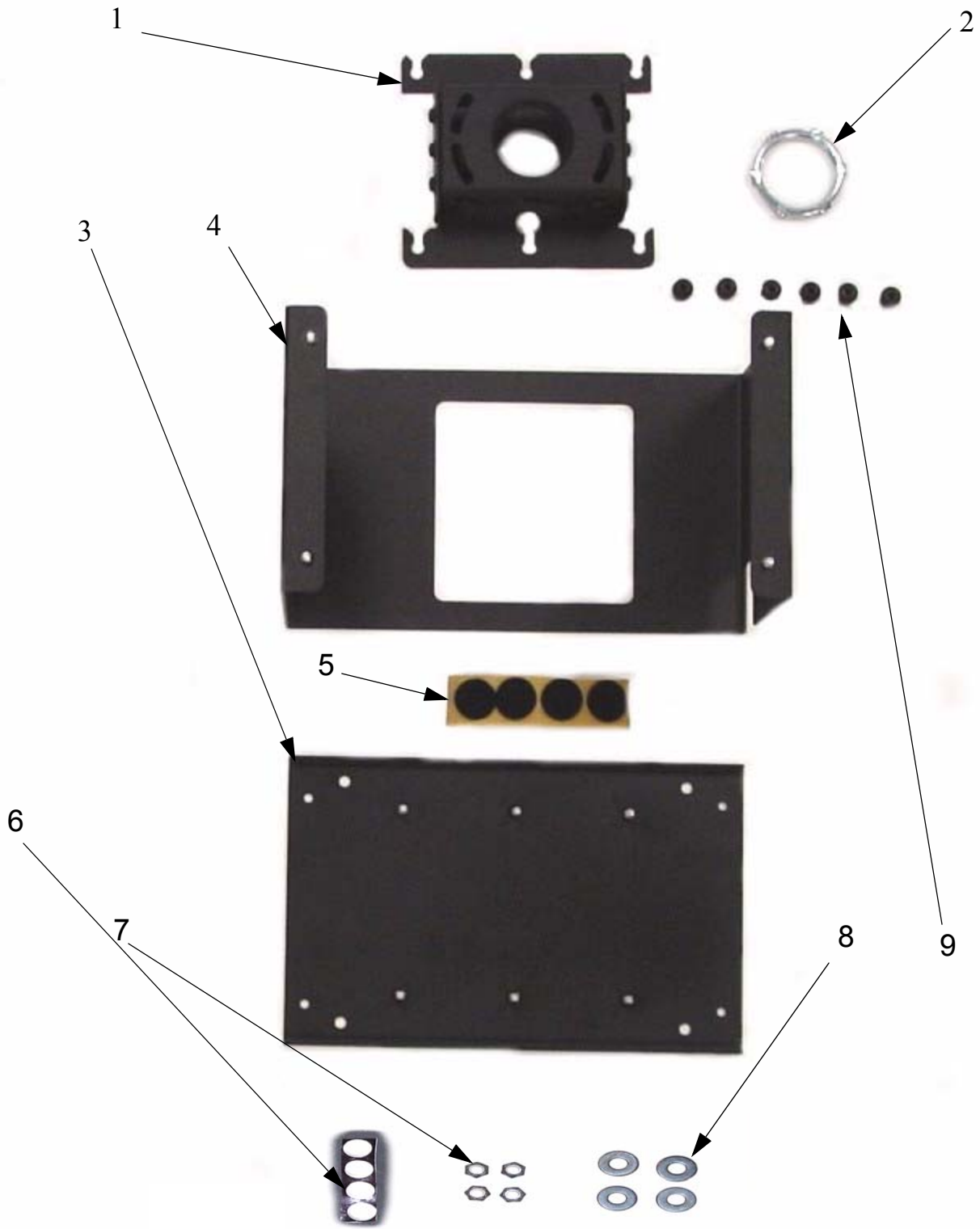

CHRISTIE Technical Support

NORTH AMERICA

CHRISTIE Digital Systems, Inc.

809 Wellington St. North
Kitchener, Ontario, Canada N2G 4Y7
Tel. 519-744-8005 (*General*)
Toll Free 1-800-221-8025
(*Technical Support*)
Fax 519-749-3302 (*Service*)

CHRISTIE Digital Systems, Inc.

10550 Camden Drive
Cypress, CA 90630USA
Tel. 714-236-8610 (*General*)
Toll Free 1-800-221-8025
(*Technical Support*)
Fax 519-749-3302 (*Service*)

EUROPE

CHRISTIE Digital Systems, Inc.

Image Point
58 Suttons Park Ave.
Reading, Berkshire RG6 1AZ
United Kingdom
Tel. +44-118-926-6300
Fax +44-118-926-6322

CHRISTIE Digital Systems, Inc.

Hohenzollernstraße 124-126
41061 Mönchengladbach
Germany
Tel. +49-2161-664540
Fax +49-2161-664546

ASIA-PACIFIC

CHRISTIE Digital Systems, Inc.

37 Tannery Lane
03-05 Tannery House
Singapore 347790
Tel. 65-749-5525
Fax 65-744-2900

CHRISTIE Sales (Canada)

Tel. 1-800-265-2171
Fax 519-749-3136

CHRISTIE Sales (U.S.)

Tel. 1-800-407-7727 or 1-800-333-3816
Fax 714-503-3375

VIVID GREEN CEILING MOUNT LINE DRAWING

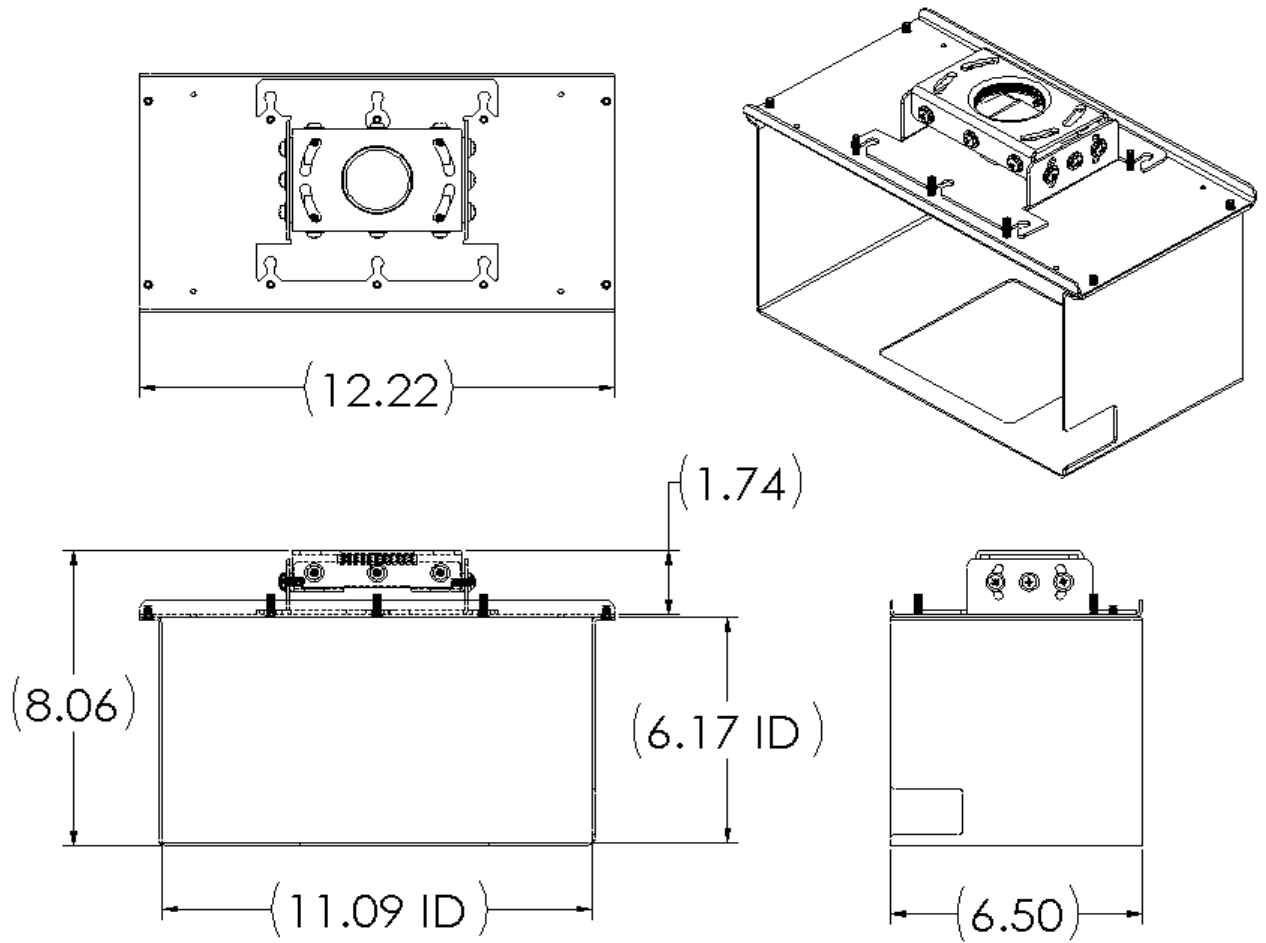

RPA LINE DRAWING

