

INSTALLATION INSTRUCTIONS

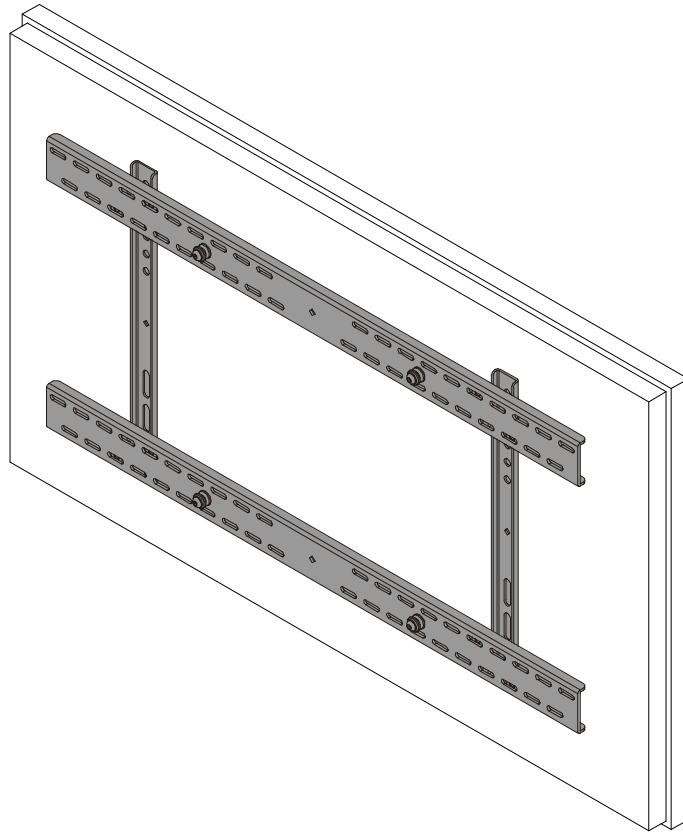

Extra Large Universal Interface Bracket

DISCLAIMER

Milestone AV Technologies, and its affiliated corporations and subsidiaries (collectively, "Milestone"), intend to make this manual accurate and complete. However, Milestone makes no claim that the information contained herein covers all details, conditions or variations, nor does it provide for every possible contingency in connection with the installation or use of this product. The information contained in this document is subject to change without notice or obligation of any kind. Milestone makes no representation of warranty, expressed or implied, regarding the information contained herein. Milestone assumes no responsibility for accuracy, completeness or sufficiency of the information contained in this document.

®Chief is a registered trademark of Milestone AV Technologies. All rights reserved.

! IMPORTANT WARNINGS AND CAUTIONS!

! WARNING: A WARNING alerts you to the possibility of serious injury or death if you do not follow the instructions.

! CAUTION: A CAUTION alerts you to the possibility of damage or destruction of equipment if you do not follow the corresponding instructions.

! WARNING: Failure to read, thoroughly understand, and follow all instructions can result in serious personal injury, damage to equipment, or voiding of factory warranty! It is the installer's responsibility to make sure all components are properly assembled and installed using the instructions provided.

! WARNING: Failure to provide adequate structural strength for this component can result in serious personal injury or damage to equipment! It is the installer's responsibility to make sure the structure to which this component is attached can support five times the combined weight of all equipment. Reinforce the structure as required before installing the component.

! WARNING: Exceeding the weight capacity of the Listed mount can result in serious personal injury or damage to equipment! The XSBU is used with several Listed flat panel mounts that have maximum weight ratings of 250 lbs (113.4 kg).

NOTE: The Listed Mount installation instructions will identify Model XSBU interface brackets, and will specify the weight rating of the mount.

DIMENSIONS

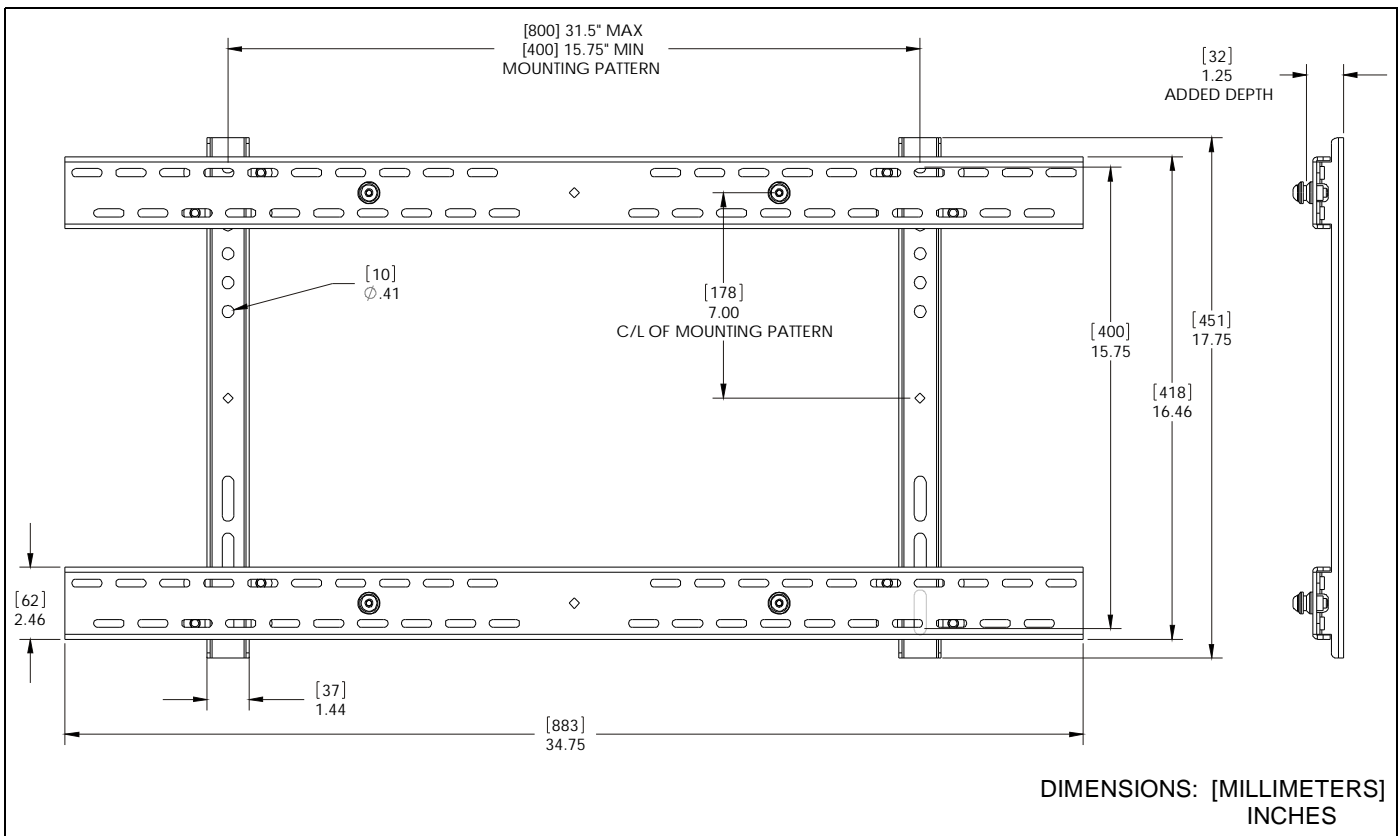

LEGEND

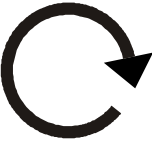
	Tighten Fastener
	Apretar elemento de fijación
	Befestigungsteil festziehen
	Apertar fixador
	Serrare il fissaggio
	Bevestiging vastdraaien
	Serrez les fixations
Сожмите Застежку	

	Hex-Head Wrench
	Llave de cabeza hexagonal
	Sechskantschlüssel
	Chave de cabeça sextavada
	Chiave esagonale
	Zeskantsleutel
	Clé à tête hexagonale
Ключ с шестигранной головкой	

	Loosen Fastener
	Aflojar elemento de fijación
	Befestigungsteil lösen
	Desapertar fixador
	Allentare il fissaggio
	Bevestiging losdraaien
	Desserrez les fixations
Ослабьте Застежку	

TOOLS REQUIRED FOR INSTALLATION / PARTS



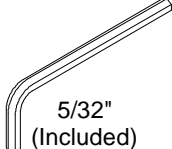

5/32"
(Included)

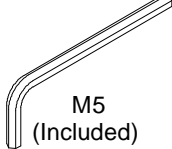

M5
(Included)



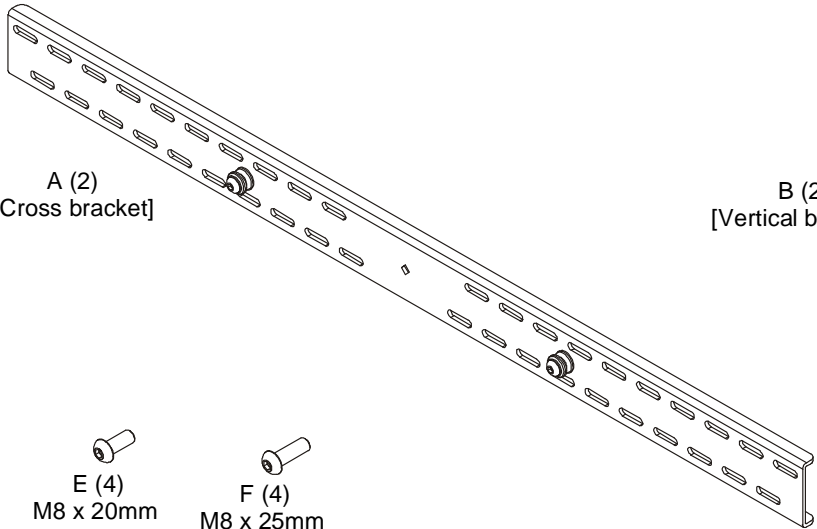

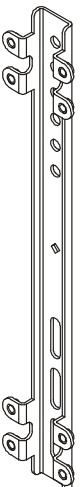

A (2)
[Cross bracket]



B (2)
[Vertical bracket]



C (8)
1/4-20 x 1/2"



D (4)
M8 x 16mm



E (4)
M8 x 20mm



F (4)
M8 x 25mm

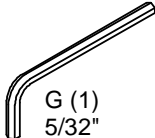

G (1)
5/32"

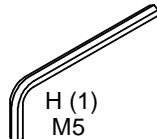

H (1)
M5

INSTALLATION



WARNING: IMPROPER INSTALLATION CAN LEAD TO MOUNT FALLING CAUSING SERIOUS PERSONAL INJURY OR DAMAGE TO EQUIPMENT! DO NOT substitute hardware. Only use hardware provided or specified by manufacturer.

1. Determine and mark the vertical center position between the left side upper and lower mounting holes in display. (See Figure 1)
2. Determine and mark the vertical center position between the right side upper and lower mounting holes in display. (See Figure 1)
3. Orient vertical bracket (B) so that mounting holes are on top and mounting slots are on bottom. (See Figure 1)
4. Align mounting holes in vertical bracket (B) with upper and lower mounting holes in display.
5. Adjust vertical bracket (B) position until mark made in Step 1 aligns with center mark in vertical bracket (B).
6. Secure left side vertical bracket (B) to display using two button head cap screws (D, E or F). (See Figure 2)



WARNING: IMPROPER INSTALLATION CAN LEAD TO DISPLAY FALLING CAUSING SERIOUS PERSONAL INJURY OR DAMAGE TO EQUIPMENT! Using screws of improper size may damage your display. Properly sized screws will easily and completely thread into display mounting holes. If spacers are required, be sure to use longer screws of the same diameter.

7. Repeat Steps 3 through 6 for right side vertical bracket using the same hole locations to align brackets horizontally.

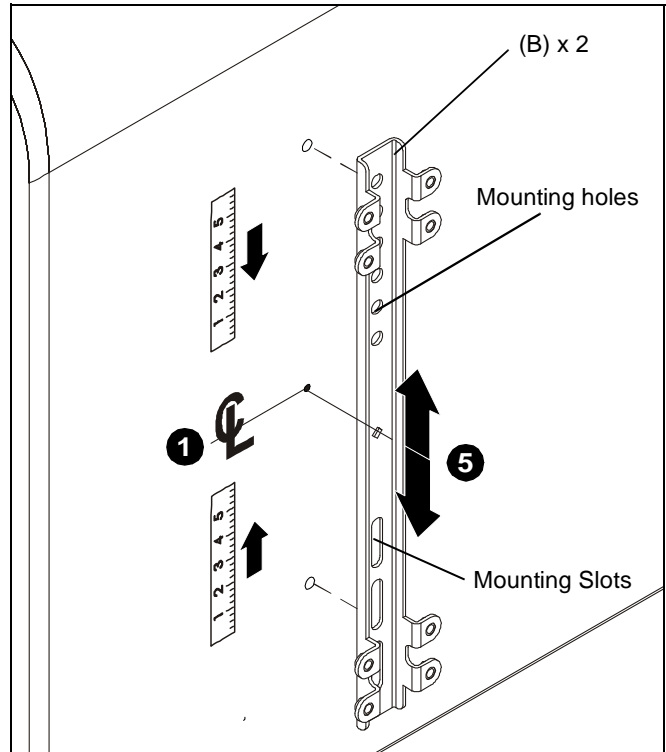

Figure 1

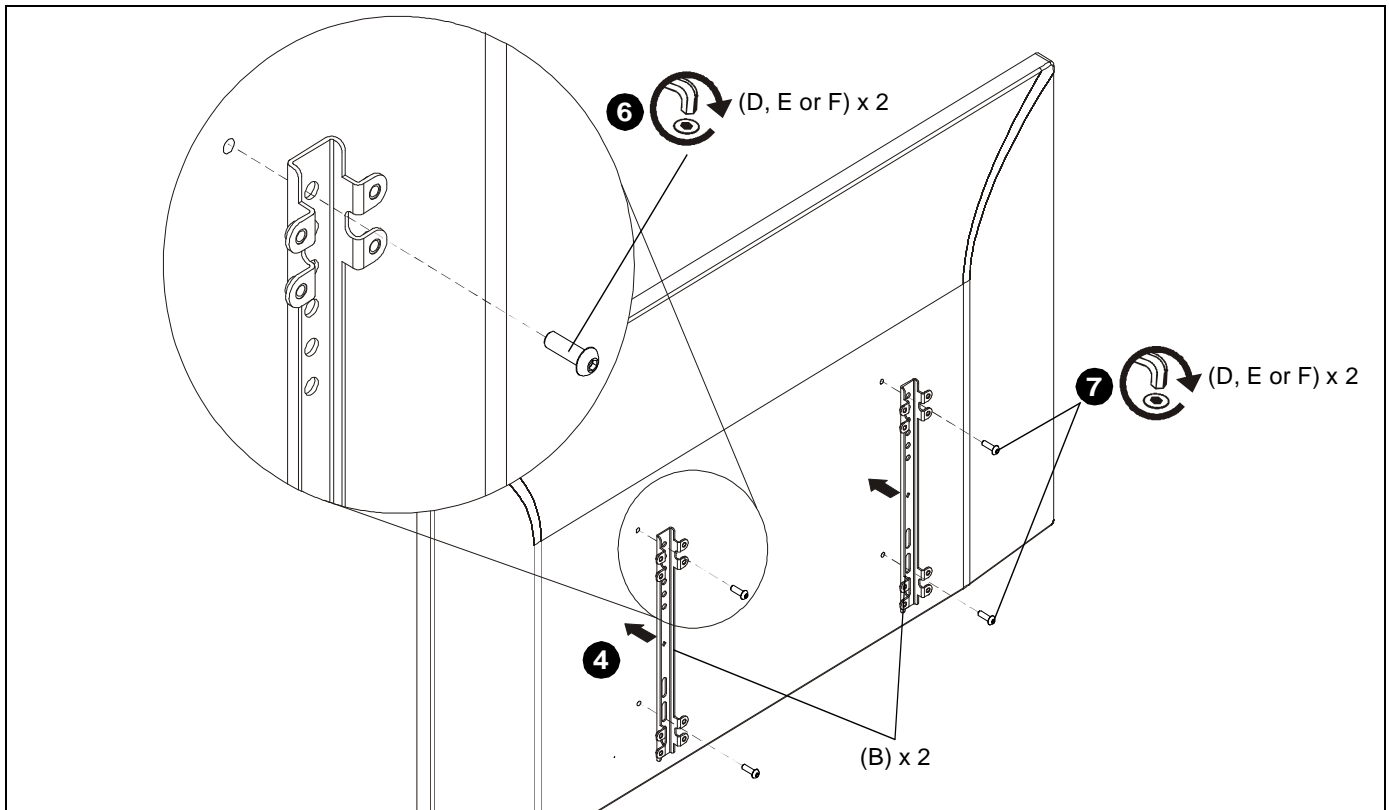

Figure 2

8. Determine and mark the horizontal center position between the left and right *TOP* mounting holes in display. (See Figure 3)
9. Determine and mark the horizontal center position between the left and right *BOTTOM* mounting holes in display.
10. Orient upper cross bracket (A) so that flanges are facing towards display and resting over mounting tabs of left and right vertical brackets (B). (See Figure 3)
11. Adjust upper cross bracket (A) position until center diamond in cross bracket (A) aligns with mark made in Step 8, and mounting slots in cross bracket (A) are aligned with threaded holes in mounting tabs of left and right vertical brackets (B). (See Figure 3) and (See Figure 4)
12. Secure upper cross bracket (A) to left and right vertical brackets (B) using four 1/4-20 x 1/2" button head cap screws (C). (See Figure 4)
13. Repeat steps 10 through 12 for lower cross bracket (A).

IMPORTANT ! : The orientation of, and mounting holes used, when installing the lower cross bracket must be the same as the upper cross bracket. Vertically align upper and lower brackets by aligning slots. (See Figure 4)

IMPORTANT ! : Whenever possible install mounting screws in a diagonal pattern on the vertical bracket mounting tabs. (See Figure 4)

14. Install display with universal interface to mount following the installation instructions provided with the mount.

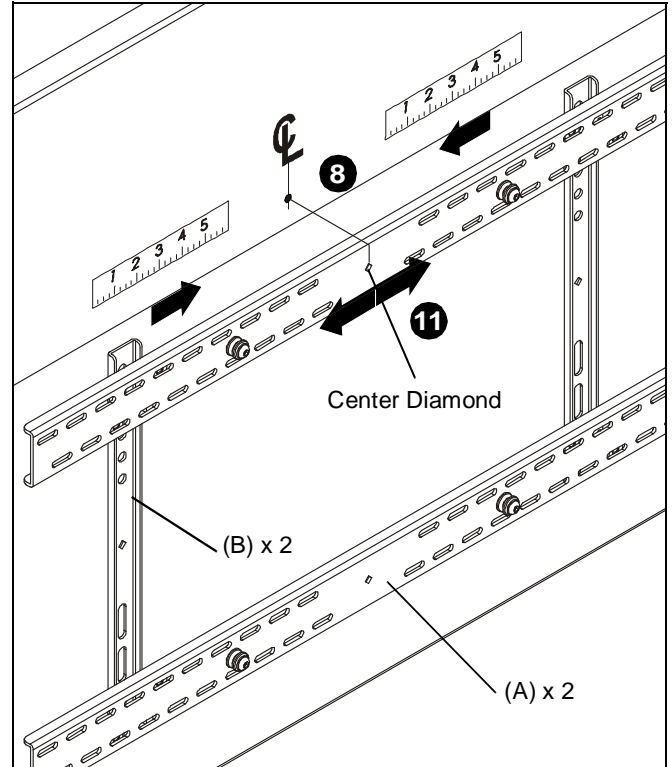

Figure 3

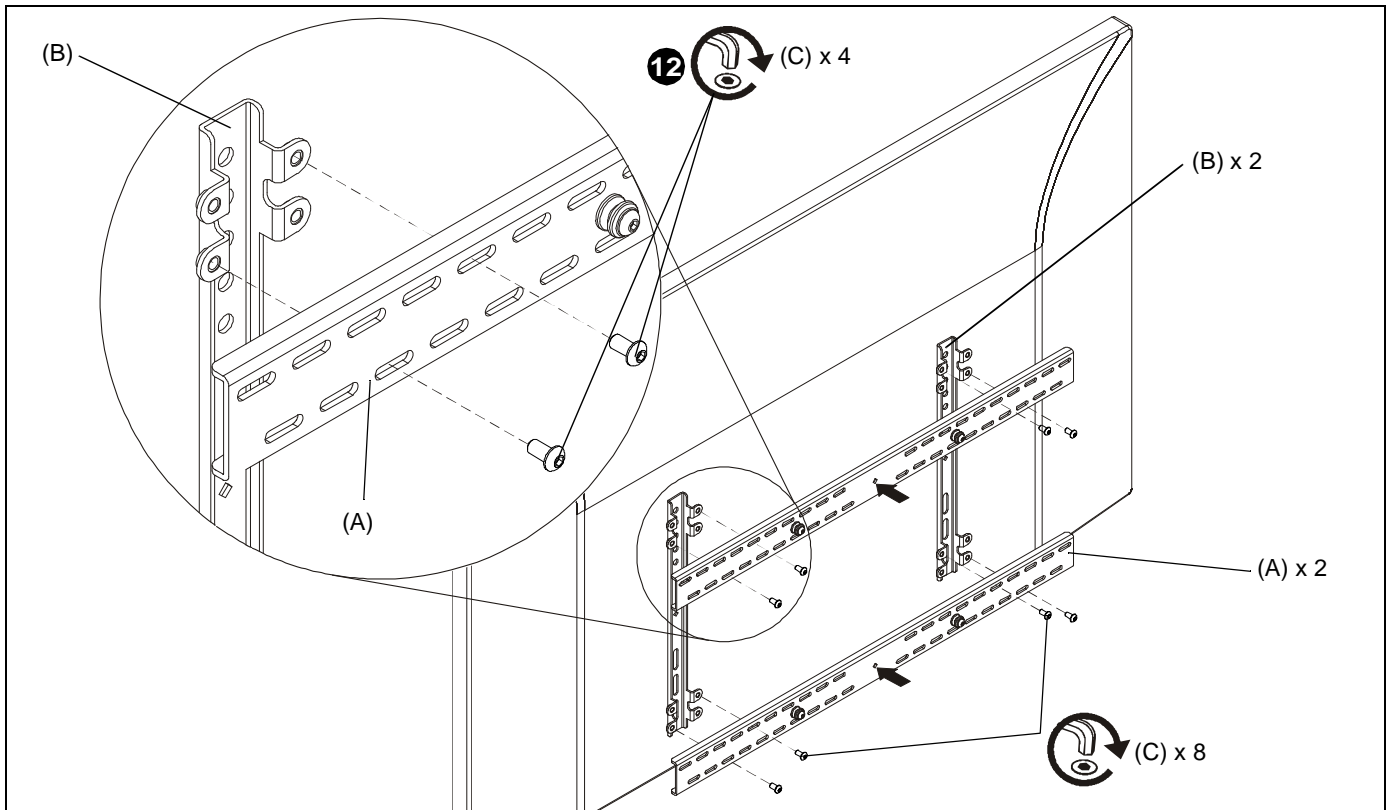

Figure 4



Chief Manufacturing, a products division
of Milestone AV Technologies

8805-002011 Rev00
©2010 Milestone AV Technologies, a
Duchossois Group Company
www.chiefmfg.com
10/10

USA/International	A 8401 Eagle Creek Parkway, Savage, MN 55378 P 800.582.6480 / 952.894.6280 F 877.894.6918 / 952.894.6918
Europe	A Fellenoord 130 5611 ZB EINDHOVEN, The Netherlands P +31 (0)40 2668620 F +31 (0)40 2668615
Asia Pacific	A Office No. 1 on 12/F, Shatin Galleria 18-24 Shan Mei Street Fotan, Shatin, Hong Kong P 852 2145 4099 F 852 2145 4477

