

1 2 3 4 5 6 7 8

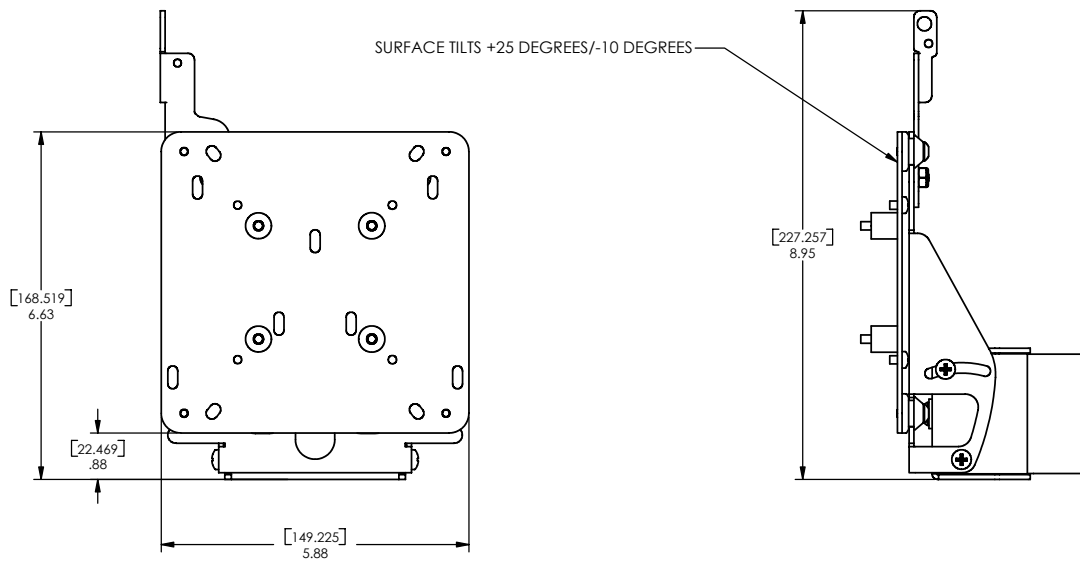
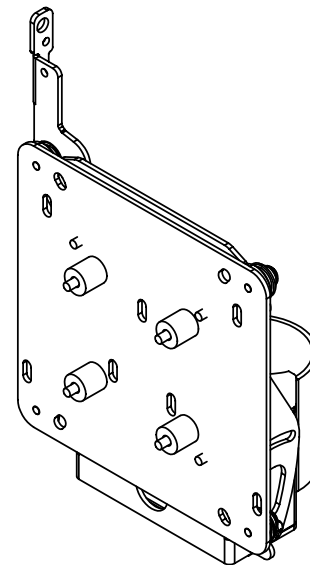
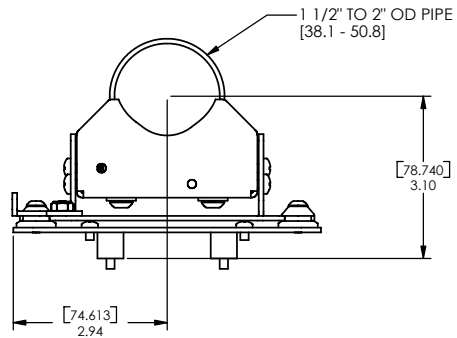

CHIEF MANUFACTURING INC.
ORDER NUMBER IS FSP-4204
PHONE: 1-800-582-6480

THE INFORMATION AND DESIGNS CONTAINED
IN THIS DRAWING ARE CONFIDENTIAL AND THE
PROPRIETARY PROPERTY OF CHIEF MFG., INC.
NEITHER THIS DESIGN NOR ANY INFORMATION
CONTAINED IN THIS DRAWING MAY BE
REPRODUCED OR DISCLOSED TO OTHERS
WITHOUT THE EXPRESS WRITTEN CONSENT OF
CHIEF MFG., INC.

CHIEF MANUFACTURING, INC.
12800 HWY 13 SOUTH STE. 500 • SAVAGE, MN. 55378
1.800.582.6480 • FAX 1.877.814.6918

TITLE
**CUSTOMER PRINT
SINGLE DISPLAY POLE MOUNT
Q2 MOUNTING SYSTEM
FSP-4204**

SIZE DWG. NO.
B FSP-4204

A

A

1 2 3 4 5 6 7 8

FSP-4204

D

C

B

A