

MAXIMUM WEIGHT
CAPACITY: 30 LBS.

VESA MOUNTING PATTERNS:
75mm X 75mm (M4 SCREWS)
100mm X 100mm (M4 SCREWS)

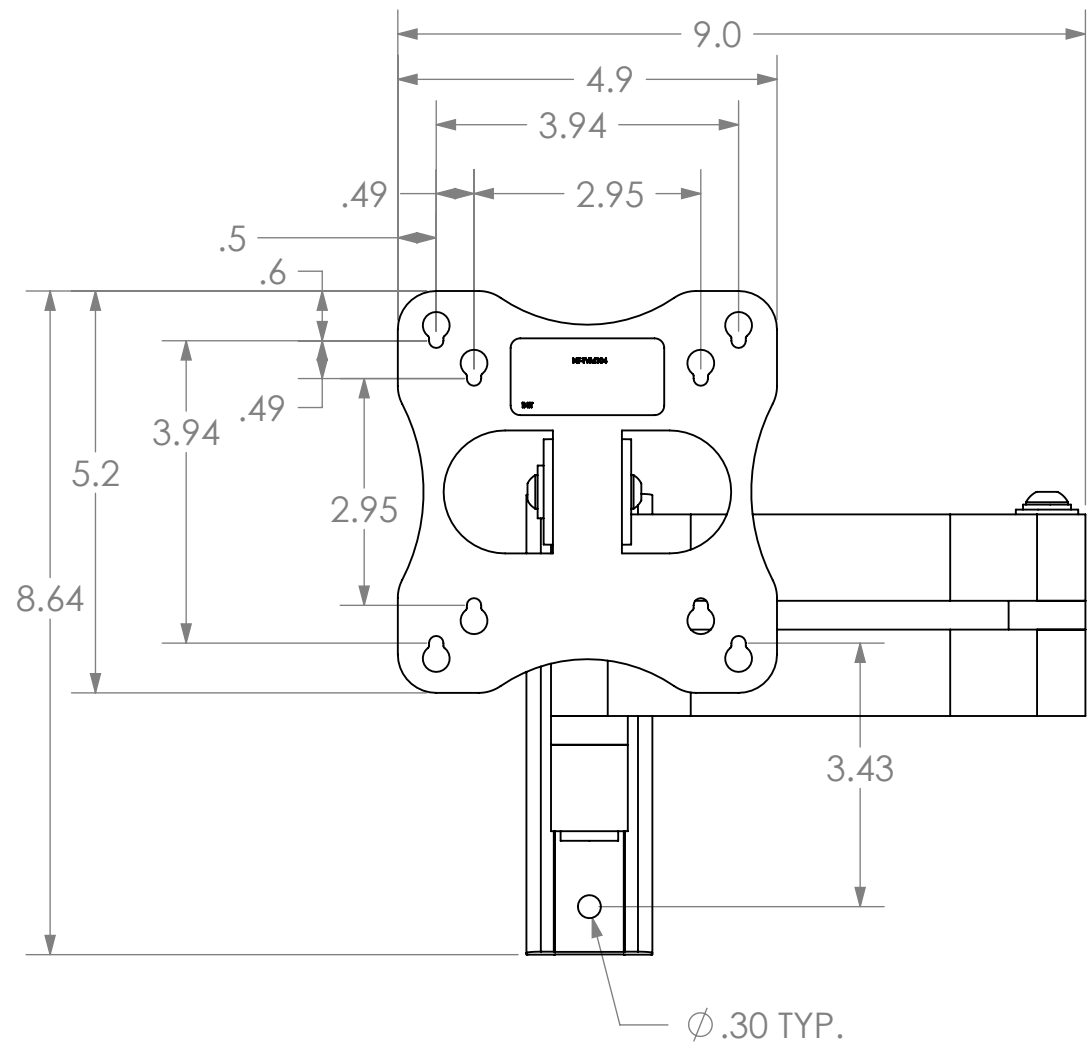

TILT:
90° UP - 20° DOWN
(DEPENDING ON
EQUIPMENT SIZE)

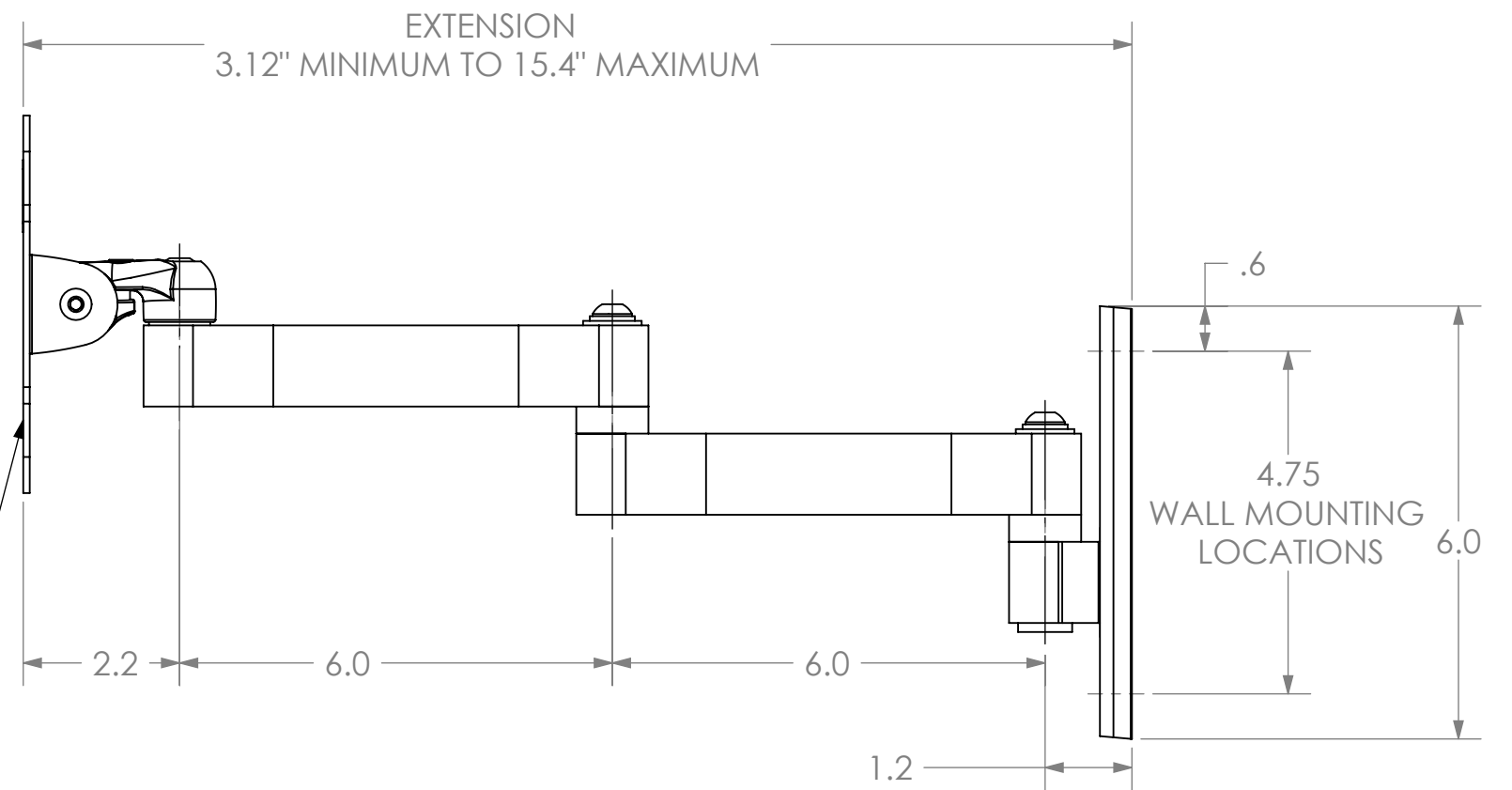
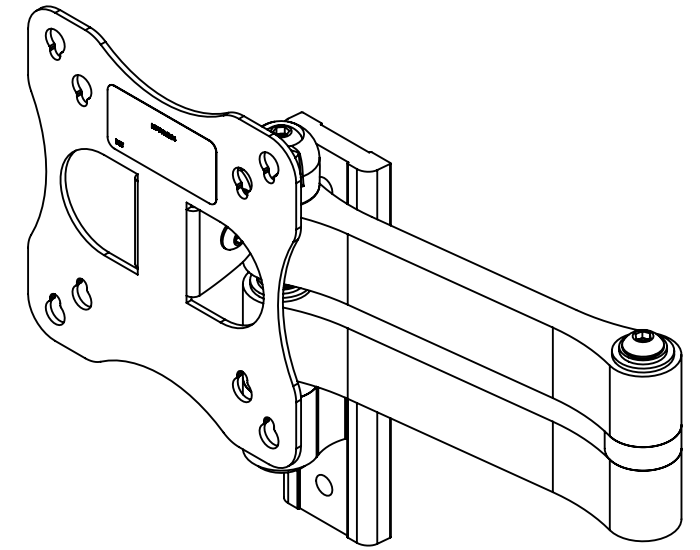

SHEET SCALE = 1:7

DRAWN BY: NLB	DATE: 6/10/07	REVISION: 00	INIT TECHNICAL DRAWING
<p>THE INFORMATION AND DESIGNS CONTAINED IN THIS DRAWING ARE CONFIDENTIAL AND THE PROPRIETARY PROPERTY OF CSAV INC. NEITHER THIS DESIGN NOR ANY INFORMATION CONTAINED IN THIS DRAWING MAY BE REPRODUCED OR DISCLOSED TO OTHERS WITHOUT THE EXPRESS WRITTEN CONSENT OF CSAV INC.</p>			<p>TITLE</p> <p>CUSTOMER PRINT NT-TVM104</p>
<p>SIZE</p> <p>B</p>			<p>SHEET 1 OF 1</p>