

NOTE: CUSTOM INTERAFCE BRACKET NOT SHOWN. THE CUSTOM INTERFACE BRACKET NEEDED FOR YOUR DISPLAY WILL ADD BETWEEN 1/2" AND 2" IN DEPTH AND MAY AFFECT LOCATION OF DISPLAY ON THE MOUNT.

SEE PSB-XXXX DRAWING ALSO.

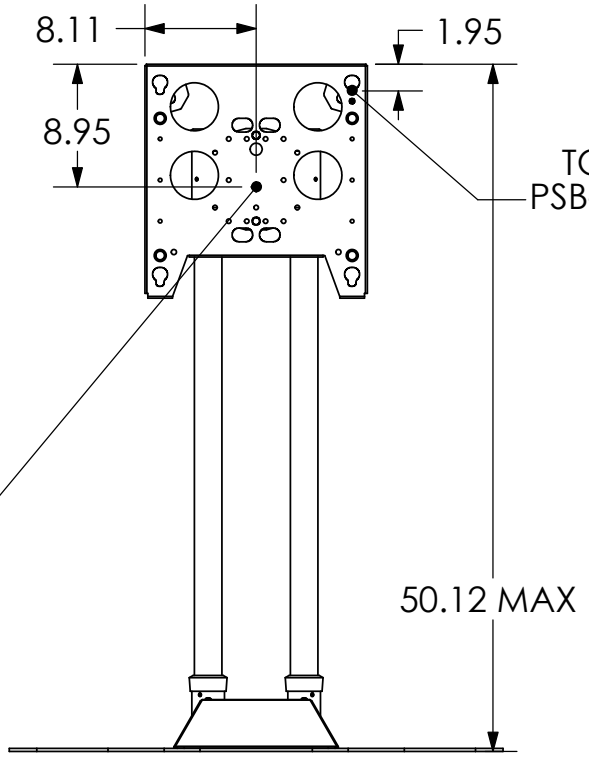

TOP MOUNTING BUTTON ON PSB-XXXX DRAWING GOES HERE

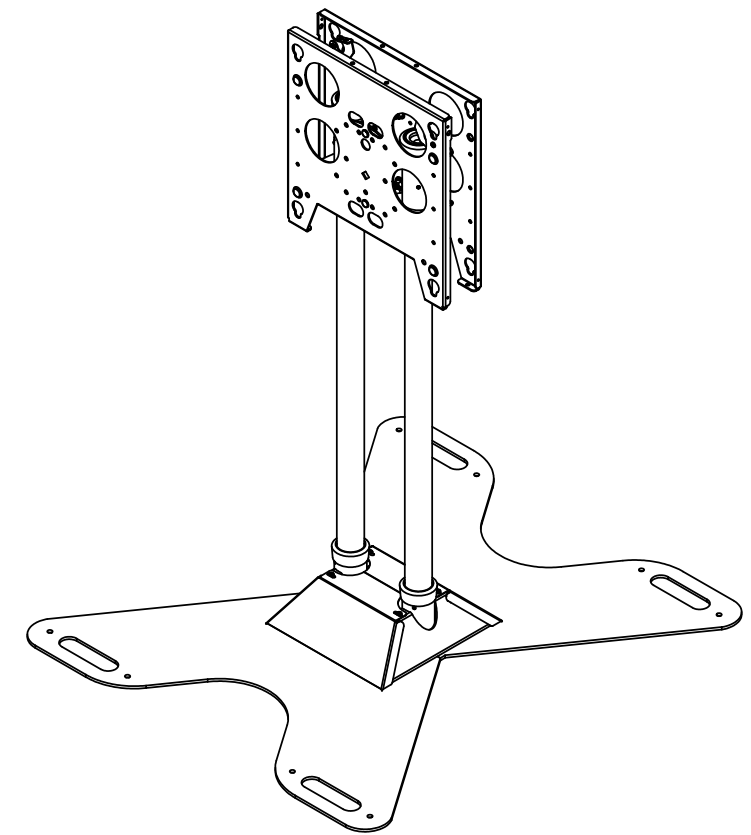
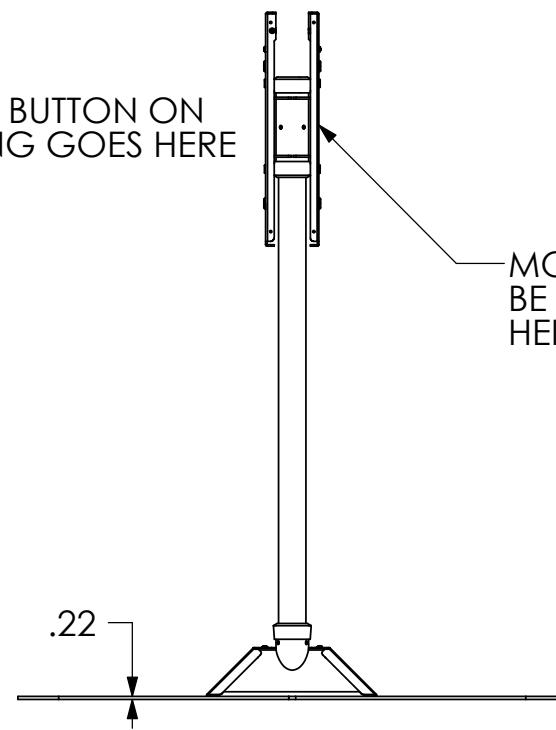

MOUNTING HEAD CAN BE PLACED AT ANY HEIGHT ON THE POSTS

APPROXIMATE CENTER OF DISPLAY



CHIEF MANUFACTURING INC.
MOUNT ORDER NUMBER IS PFB-2045DB
PHONE: 1-800-582-6480

SHEET SCALE = 1:14

THE INFORMATION AND DESIGNS CONTAINED IN THIS DRAWING ARE CONFIDENTIAL AND THE PROPRIETARY PROPERTY OF CHIEF MFG., INC. NEITHER THIS DESIGN NOR ANY INFORMATION CONTAINED IN THIS DRAWING MAY BE REPRODUCED OR DISCLOSED TO OTHERS WITHOUT THE EXPRESS WRITTEN CONSENT OF CHIEF MFG., INC.

CHIEF MANUFACTURING, INC. <small>8401 EAGLE CREEK PKWY STE. 700, SAVAGE, MN 55378 1.800.582.6480 * FAX 1.877.894.6918</small>	
TITLE CUSTOMER PRINT PFB-2045DB	
SIZE B	DWG. NO. PFB-2045DB