

1 2 3 4 5 6 7 8

D

C

B

A

PWL-2232

D

C

B

A

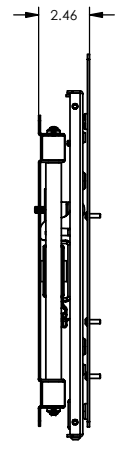
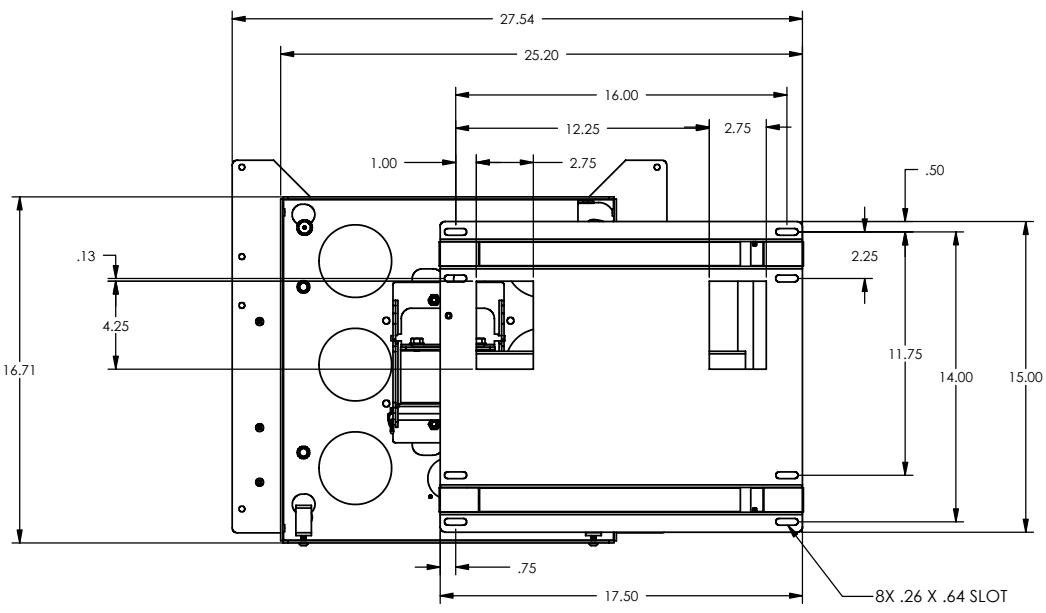
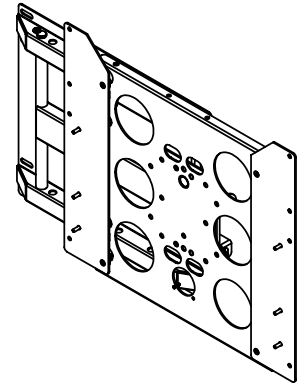
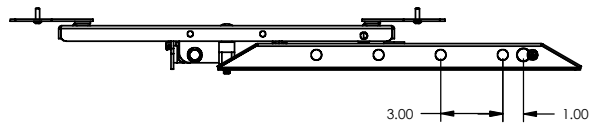

CHIEF MANUFACTURING INC.
MOUNT ORDER NUMBER IS PWL-2232
PHONE: 1-800-582-6480

THE INFORMATION AND DESIGNS CONTAINED
 IN THIS DRAWING ARE CONFIDENTIAL AND THE
 PROPRIETARY PROPERTY OF CHIEF MFG., INC.
 NEITHER THIS DESIGN NOR ANY INFORMATION
 CONTAINED IN THIS DRAWING MAY BE
 REPRODUCED OR DISCLOSED TO OTHERS
 WITHOUT THE EXPRESS WRITTEN CONSENT OF
 CHIEF MFG., INC.

CHIEF MANUFACTURING, INC.
 12800 HWY 13 SOUTH STE. 500 • SAVAGE, MN 55378
 1.800.582.6480 • Fax 1.877.894.6918

TITLE
**CUSTOMER PRINT
 ASSEMBLY, WALL MOUNT, PITCH,
 LONG ARM, PWL-2232**

SIZE DWG. NO.
B PWL-2232

1 2 3 4 5 6 7 8